



**01**

**EN**

**Anaesthesia**

**DE**

**Narkose**

**ES**

**Anestesia**



**ANAESTHESIA**

Fiber Optic Laryngoscopes and Accessories  
Kaltlicht-Laryngoskope und Zubehör  
Laringoscopios de luz fría y accesorios

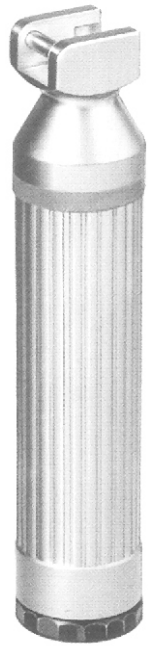

01-1001-00  
Battery handle



fiber optic

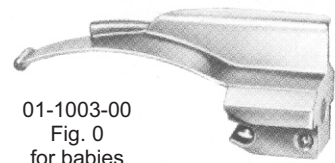

01-1003-00  
Fig. 0  
for babies  
55 mm



01-1003-01  
Fig. 1  
for children  
70 mm



01-1003-02  
Fig. 2  
for adolescents  
80 mm

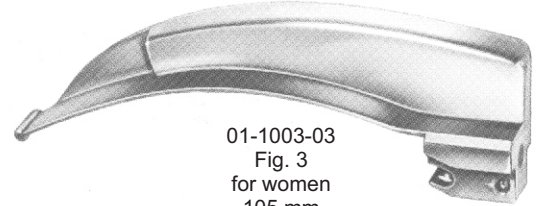

01-1003-03  
Fig. 3  
for women  
105 mm

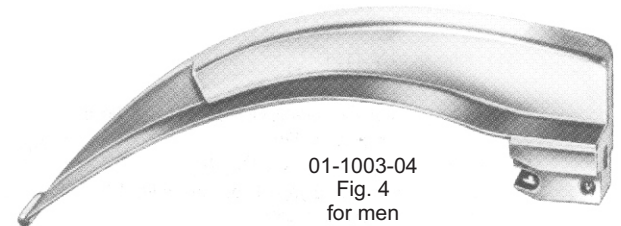

01-1003-04  
Fig. 4  
for men  
130 mm



**McINTOSH**  
with fiberoptic

01-1002-00  
set with 4 blades, battery handle  
(without batteries)  
Fig. 1 to 4, in case



**FOREGGER**  
with fiberoptic

01-1004-00  
set with 4 blades, battery handle  
(without batteries)  
Fig. 1 to 4, in case

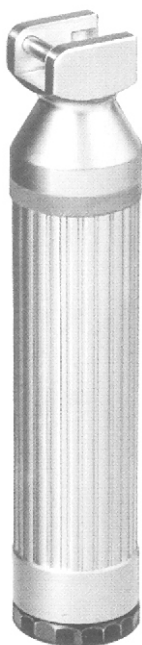

01-1005-00  
Battery handle



Laryngoscope Sets  
fiber optic

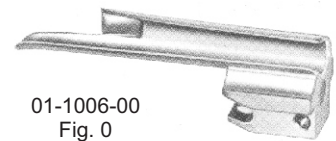

01-1006-00  
Fig. 0  
for babies  
55 mm



01-1006-01  
Fig. 1  
for children  
70 mm



01-1006-02  
Fig. 2  
for adolescents  
90 mm



01-1006-03  
Fig. 3  
for women  
110 mm

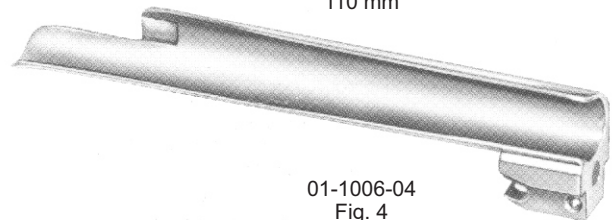

01-1006-04  
Fig. 4  
for men  
135 mm



**ANAESTHESIA**

Fiber Optic Laryngoscopes and Accessories  
Kaltlicht-Laryngoskope und Zubehör  
Laringoscopios de luz fría y accesorios



Laryngoscope Sets  
fiber optic

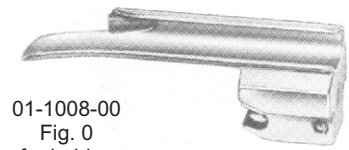

01-1008-00  
Fig. 0  
for babies  
55 mm

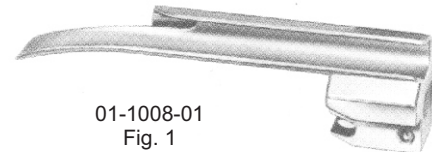

01-1008-01  
Fig. 1  
for children  
80 mm

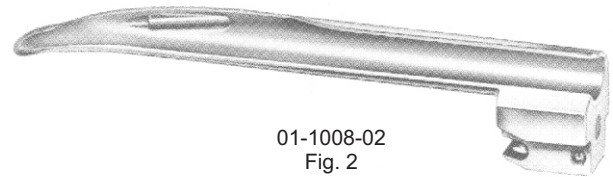

01-1008-02  
Fig. 2  
for adolescents  
130 mm

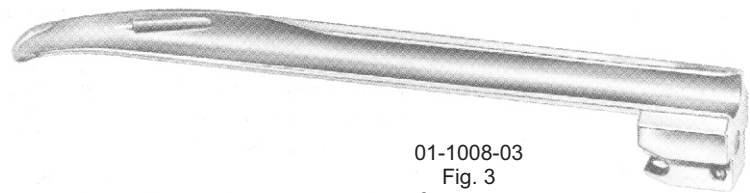

01-1008-03  
Fig. 3  
for women  
170 mm

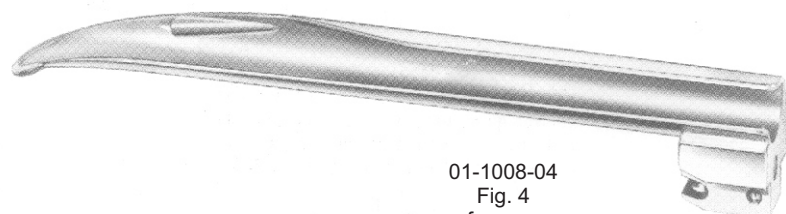

01-1008-04  
Fig. 4  
for men  
180 mm

**MILLER**

01-1007-00  
with battery handle (without batteries)  
and three laryngoscope blades  
fig. 1 to 3, complete, in case



fiber optic



01-1009-00  
 Battery handle (without batteries)  
 with halogen bulb and green ring



01-1010-00  
 Battery handle (without batteries)  
 with halogen bulb and green ring



01-1011-00  
 Spare bulb  
 Krypton 2.5 V



01-1012-00  
 Spare bulb  
 Xenon 2.5 V



01-1013-00  
 Spare bulb  
 Halogen 2.5 V



**ANAESTHESIA**

Laryngoscopes  
Laryngoskope  
Laringoscopios



**Miller**  
01-1014-30  
01-1014-40

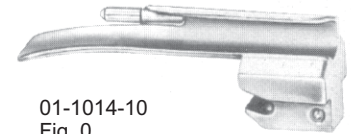

01-1014-10  
Fig. 0  
55 mm



01-1014-11  
Fig. 1



01-1014-12  
Fig. 2



01-1014-13  
Fig. 3

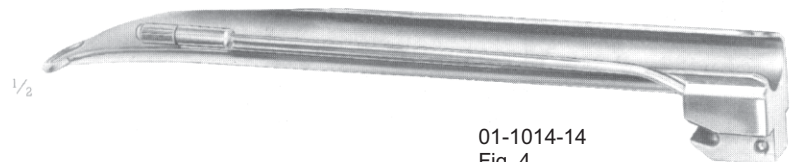

01-1014-14  
Fig. 4

01-1014-30  
Laryngoscope Set  
Consisting of:  
01-1014-00 Battery Handle (without batteries)  
01-1014-11 McIntosh blade, Fig 1  
01-1014-12 ditto, Fig 2  
01-1014-13 ditto, Fig 3

01-1014-40  
Laryngoscope Set  
Consisting of:  
01-1014-00 Battery Handle (without batteries)  
01-1014-11 McIntosh blade, Fig 1  
01-1014-12 McIntosh blade, Fig 2  
01-1014-13 McIntosh blade, Fig 3  
01-1014-14 McIntosh blade, Fig 4

McIntosh Laryngoscope Blades  
01-1014-10 Fig 0, Working length 55mm, baby's  
01-1014-11 Fig 1, Working length 75mm, children's  
01-1014-12 Fig 2, Working length 90mm, adolescent's  
01-1014-13 Fig 3, Working length 110mm, women's  
01-1014-14 Fig 4, Working length 135mm, men's

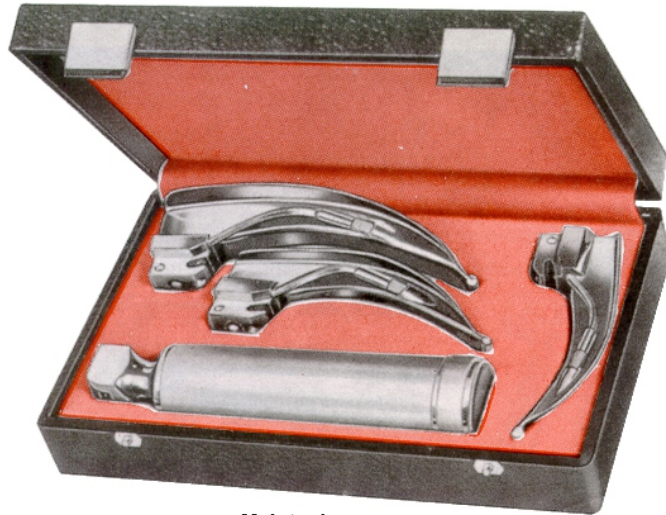

**McIntosh**  
01-1015-30  
01-1015-40

01-1015-30  
Laryngoscope Set  
Consisting of:  
01-1015-00 Battery Handle (without batteries)  
01-1015-11 McIntosh blade, Fig 1  
01-1015-12 ditto, Fig 2  
01-1015-13 ditto, Fig 3

01-1015-40  
Laryngoscope Set  
Consisting of:  
01-1015-00 Battery Handle (without batteries)  
01-1015-11 McIntosh blade, Fig 1  
01-1015-12 McIntosh blade, Fig 2  
01-1015-13 McIntosh blade, Fig 3  
01-1015-14 McIntosh blade, Fig 4



**McIntosh Laryngoscope Blades**  
01-1015-10 Fig 0, Working length 55mm, baby's  
01-1015-11 Fig 1, Working length 75mm, children's  
01-1015-12 Fig 2, Working length 90mm, adolescent's  
01-1015-13 Fig 3, Working length 110mm, women's  
01-1015-14 Fig 4, Working length 135mm, men's



## ANAESTHESIA

Laryngoscopes  
Laryngoskope  
Laringoscopios



**Foregger**  
01-1016-30  
01-1016-40

01-1016-30  
Laryngoscope Set  
Consisting of:  
01-1016-00 Battery Handle (without batteries)  
01-1016-12 Foregger Blade, Fig 2  
01-1016-13 ditto, Fig 3  
01-1016-14 ditto, Fig 4

01-1016-40  
Laryngoscope Set  
Consisting of:  
01-1016-00 Battery Handle (Without batteries)  
01-1016-11 Foregger Blade, Fig 1  
01-1016-12 Foregger Blade, Fig 2  
01-1016-13 Foregger Blade, Fig 3  
01-1016-14 Foregger Blade, Fig 4

01-1016-11



01-1016-12



01-1016-13

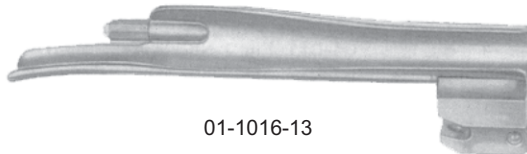

01-1016-14

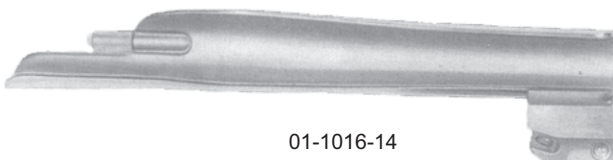

Foregger Laryngoscope Blade,  
01-1016-11 Fig 1, working length 70mm, children's  
01-1016-12 Fig 2, working length 90mm, adolescent's  
01-1016-13 Fig 3, working length 110mm, women's  
01-1016-14 Fig 4, working length 135mm, men's





01-1017-30  
Laryngoscope Set  
Consisting of:  
01-1017-00 Battery Handle (without batteries)  
01-1017-12 Guedel-Negus Blade, Fig 2  
01-1017-13 ditto, Fig 3  
01-1017-14 ditto, Fig 4

**Guedel-Negus**  
01-1017-30  
01-1017-40

01-1017-40  
Laryngoscope Set  
Consisting of:  
01-1017-00 Battery Handle (without batteries)  
01-1017-11 Guedel-Negus Blade, Fig 1  
01-1017-12 Guedel-Negus Blade, Fig 2  
01-1017-13 Guedel-Negus Blade, Fig 3  
01-1017-14 Guedel-Negus Blade, Fig 4



01-1017-11



01-1017-12



01-1017-13

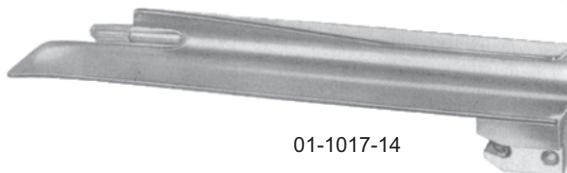

01-1017-14

**Guedel Laryngoscope Blades**  
01-1017-11 Fig 1, working length 70mm, children's  
01-1017-12 Fig 2, working length 90mm, adolescent's  
01-1017-13 Fig 3, working length 110mm, women's  
01-1017-14 Fig 4, working length 135mm, men's



COLD LIGHT LARYNGOSCOPIES



01-1018-00  
handle with lamp

McINTOSH  
with fiberoptic

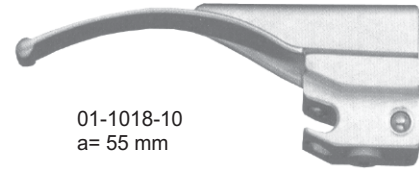
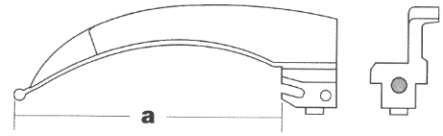

01-1018-10  
a= 55 mm

Fig. 0

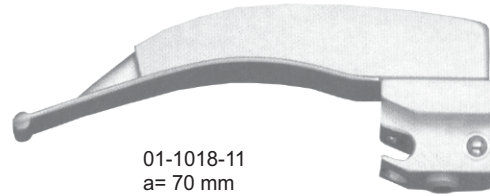

01-1018-11  
a= 70 mm

Fig. 1

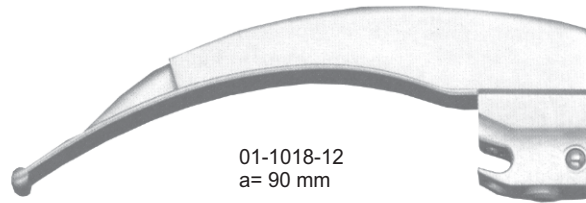

01-1018-12  
a= 90 mm

Fig.2

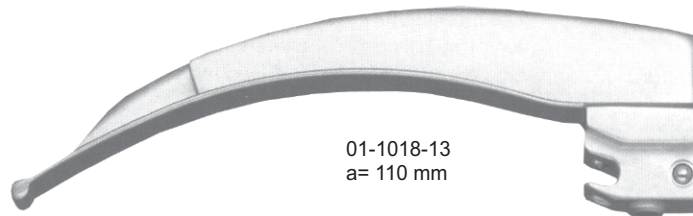

01-1018-13  
a= 110 mm

Fig. 3

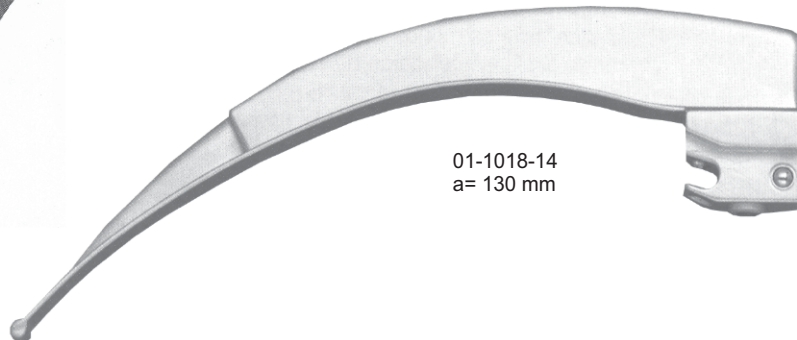

01-1018-14  
a= 130 mm

Fig.4



01-1018-50  
set with 5 blades



COLD LIGHT LARYNGOSCOPES



04-1306-50  
set with 5 blades



01-1019-00  
handle with lamp

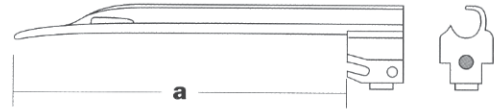

a

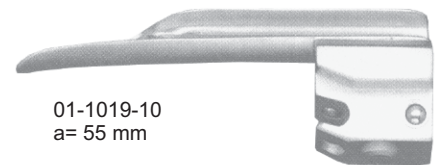

01-1019-10  
a= 55 mm

Fig. 0

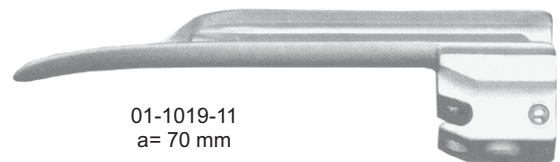

01-1019-11  
a= 70 mm

Fig. 1

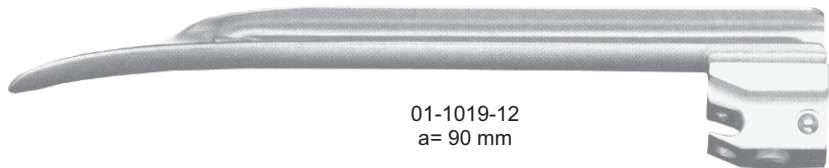

01-1019-12  
a= 90 mm

Fig.2

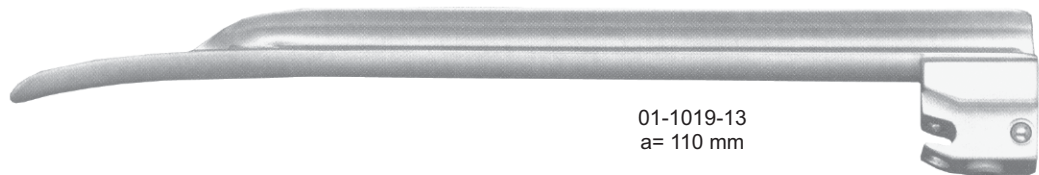

01-1019-13  
a= 110 mm

Fig. 3



01-1019-14  
a= 130 mm

Fig.4



**ANAESTHESIA**

Laryngoscopes  
Laryngoskope  
Laringoscopios



Working length 55 mm  
01-1020-10

Working length 80 mm  
01-1020-11

**Miller-Baby**  
01-1020-20

01-1020-20  
Laryngoscope Set, Baby and Infant,  
consisting of :  
01-1020-00 Battery Handle (without battery)  
01-1020-10 Miller-baby blade, Fig 0  
working length 55 mm  
01-1020-11 ditto, Fig 1 working length 80 mm



**Negus**  
18 mm dia  
01-1021-00



**Conventional Handles**

	Size	Batteries
01-1022-01	Medium/Standard	2C
01-1022-02	Small/Penlight	2AA
01-1022-03	Stubby	2AA
01-1022-04	Large	2D



**Fiber Optic Handles**

	Size	Batteries
01-1023-01	Medium/Standard	2C
01-1023-02	Small/Penlight	2AA
01-1023-03	Stubby	2AA
01-1023-04	Large	2D

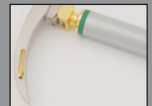

**Schimmelbusch**  
 01-1024-01 Child  
 01-1024-02 Adult



**Magill**  
 01-1025-15 15 cm/6" Infant  
 01-1025-20 20 cm/8" Child  
 01-1025-25 25 cm/10" Adult



**Yankauer**  
 01-1026-01 Child  
 01-1026-02 Adult



**Connel**  
 01-1027-01 Child  
 01-1027-02 Adult

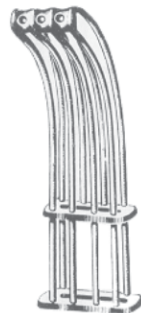

01-1028-01



**Lumbard-Mayo**  
 01-1028-02



01-1028-03

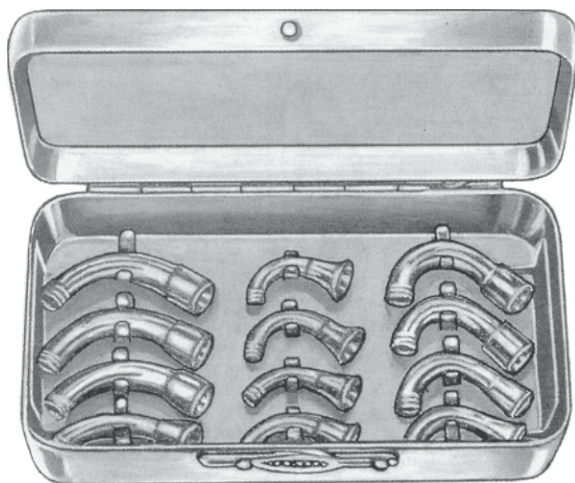
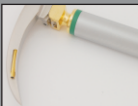

**Magill**  
 Connection Set  
 01-1029-00



<b>Magill (Nasal)</b>	
	mm dia
01-1029-01	5.5
01-1029-02	6.5
01-1029-03	7.5
01-1029-04	8.0
01-1029-05	8.5
01-1029-06	9.5
01-1029-07	10.0
01-1029-08	10.5



<b>Magill (Aural)</b>	
	mm dia
01-1030-01	5.5
01-1030-02	6.5
01-1030-03	7.5
01-1030-04	8.0
01-1030-05	8.5
01-1030-06	9.5
01-1030-07	10.0
01-1030-08	10.5



**Cobb**  
 01-1031-01 Small  
 01-1031-02 Medium  
 01-1031-03 Large

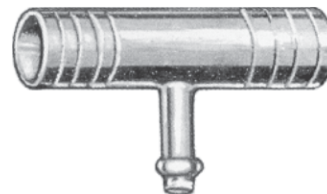

**Ayre**  
 01-1032-01 Small  
 01-1032-02 Medium  
 01-1032-03 Large



**Hamilton Bailey**  
 01-1033-01 Infant  
 01-1033-02 Child  
 01-1033-03 Adult



**Mitchell**  
 01-1034-18  
 01-1034-20  
 38 mm