



nadeem
SURGICAL CORPORATION (PVT) LTD.



07

- EN** Artery Forceps
- DE** Arterienklemmen
- ES** Pinzas hemostáticas

Page 119 to 153



Forceps
Hemostatic Forceps
Aterien
Pinzas hemostáticas



Terrier
07-2101-10 10 cm/4"



Pennington
07-2102-15 15 cm/6"
07-2102-20 20 cm/8"



Pean
07-2103-12 12.5 cm/5"

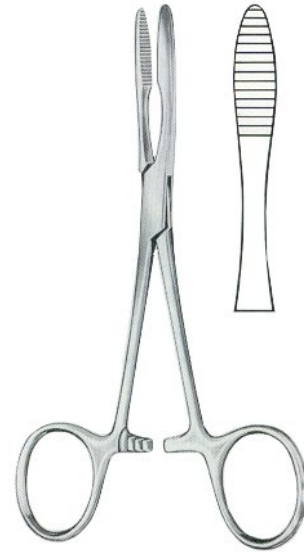

Pean
07-2104-14 14 cm/5 3/4"
07-2104-16 16 cm/6 1/4"

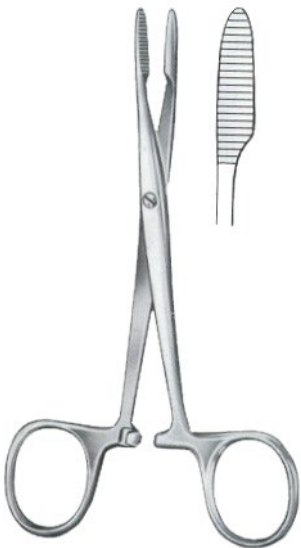

Pean
07-2105-14 14 cm/5 1/2"



Collin
07-2106-15 15.5 cm/6"



Collin
07-2107-14 14 cm/5 1/2"



Collin
07-2108-16 16.5 cm/6 1/2"



Forceps
Hemostatic Forceps
Aterien
Pinzas hemostáticas



Hartmann
10 cm/4"



07-2109-10



07-2110-10



07-2111-10



07-2112-10



Halstead-Mosquito
12 cm/4¾"
14 cm/5½"



07-2113-12
07-2113-14



07-2114-12
07-2114-14



07-2115-12
07-2115-14



07-2116-12
07-2116-14



Micro-Mosquito
10 cm/4"
12 cm/4¾"
14 cm/5½"



07-2117-10
07-2117-12



07-2118-10
07-2118-12
07-2118-14



07-2119-10
07-2119-12



07-2120-10
07-2120-12



Jacobson-Halstead
13 cm/5"



07-2121-13



07-2122-13

Very fine

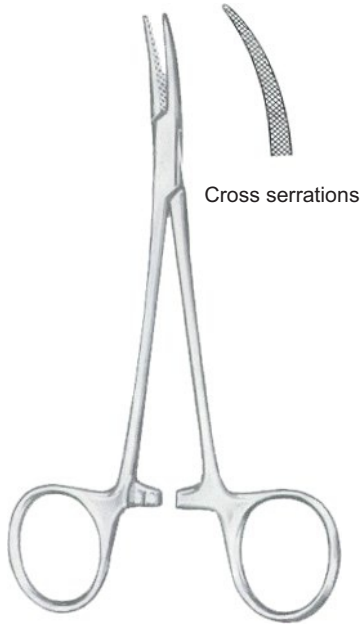

Cross serrations

07-2123-12
 12 cm/4¾"



Halstead-Mosquito
 18 cm/7"
 21 cm/8¼"



07-2124-18
 07-2124-21



07-2125-18
 07-2125-21



07-2126-18
 07-2126-21



07-2127-18
 07-2127-21



Kelly
 14 cm/5½"

Kelly-Rankin
 16 cm/6¼"



07-2128-14



14 cm/5½" 07-2129-14



07-2130-16



16 cm/6¼" 07-2131-16



Forceps
Hemostatic Forceps
Aterien
Pinzas hemostáticas



Crile
14 cm/5½"

Crile-Rankin
16 cm/6¼"



07-2132-14



14 cm/5½" 07-2133-14



07-2134-16



16 cm/6¼" 07-2135-16



Baby-Crile
14 cm/5½"



07-2136-14



07-2137-14



Crile
14 cm/5½"

Crile-Rankin
16 cm/6¼"



07-2138-14



14 cm/5 ½" 07-2139-14



07-2140-16



16 cm/6 ¼" 07-2141-16



Baby-Crile
14 cm/5½"



07-2142-14



07-2143-14



Coller-Crile

07-2144-14 14 cm/5 ½ 07-2145-14

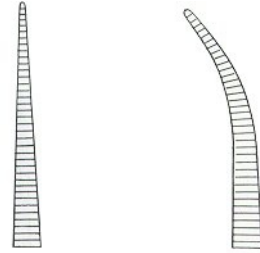

07-2146-16 16 cm/6 ¼ 07-2147-16

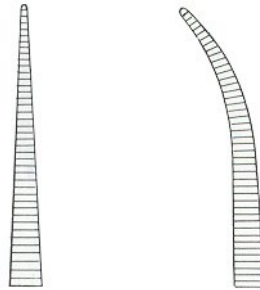

Coller-Crile
07-2148-16
16 cm/6 ¼"



Leriche
15 cm/6"

07-2149-15



07-2150-15



07-2151-15



07-2152-15



Providence
14 cm/5 ½"

07-2153-14



07-2154-14



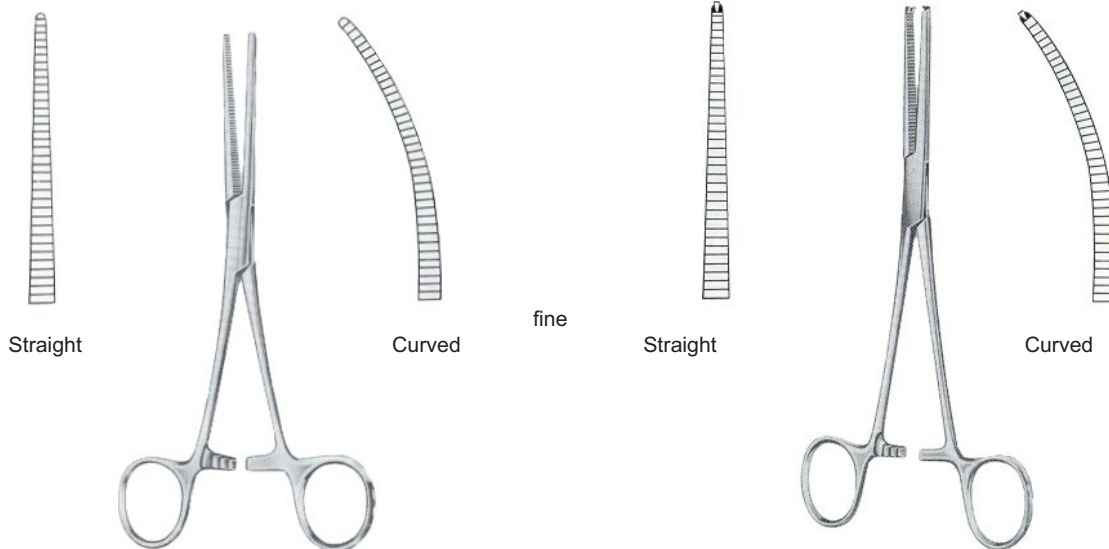

Rochester-Pean		cm	in	Ochsner-Kocher	
07-2155-13	07-2156-13	13.0	5"	07-2157-13	07-2158-13
07-2155-14	07-2156-14	14.0	5½"	07-2157-14	07-2158-14
07-2155-16	07-2156-16	16.0	6¼"	07-2157-16	07-2158-16

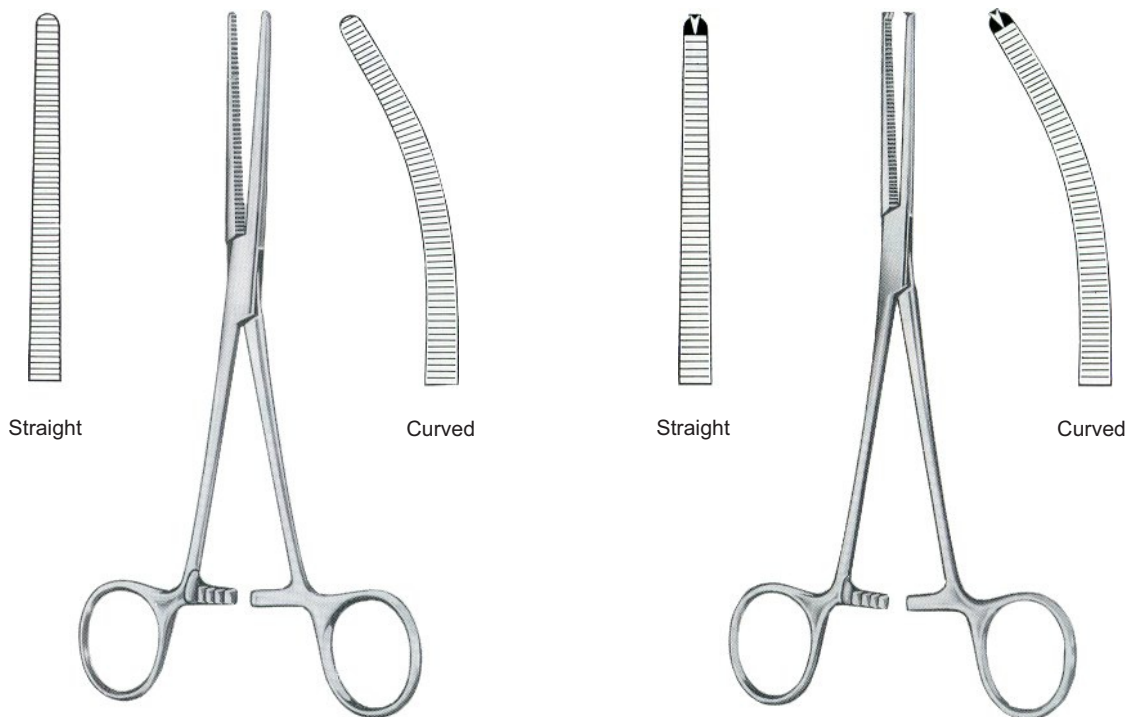

Rochester-Pean		cm	in	Ochsner-Kocher	
07-2159-13	07-2160-13	13.0	5"	07-2161-13	07-2162-13
07-2159-14	07-2160-14	14.0	5½"	07-2161-14	07-2162-14
07-2159-16	07-2160-16	16.0	6¼"	07-2161-16	07-2162-16
07-2159-18	07-2160-18	18.0	7"	07-2161-18	07-2162-18
07-2159-20	07-2160-20	20.0	8"	07-2161-20	07-2162-20
07-2159-22	07-2160-22	22.0	8¾"	07-2161-22	07-2162-22
07-2159-24	07-2160-24	24.0	9½"	07-2161-24	07-2162-24
07-2159-26	07-2160-26	26.0	10¼"	07-2161-26	07-2162-26
07-2159-30	07-2160-30	30.0	12"	07-2161-30	07-2162-30

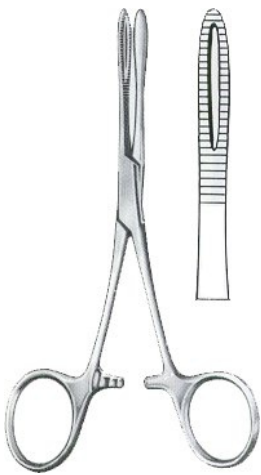

Kronlein
 07-2163-13
 13cm/5"



Brand
 07-2164-15 15cm/6"
 07-2164-19 19cm/7 1/2"
 07-2164-24 24cm/9 1/2"



Brand
 07-2165-15 15cm/6"
 07-2165-19 19cm/7 1/2"
 07-2165-24 24cm/9 1/2"

Lateral Curved

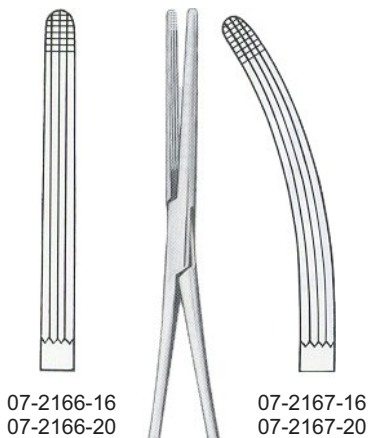

Rochester-Carmalt
 16cm/6 1/4"
 20cm/8"

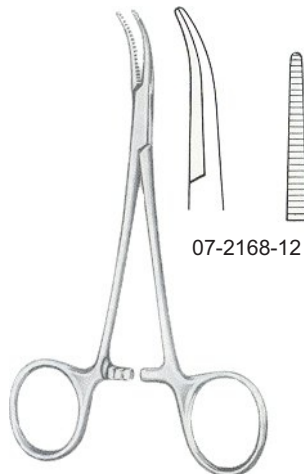

Mosquito-Dandy
 12cm/4 3/4"



Dandy
 14cm/5 1/2"



Forceps
Hemostatic Forceps
Aterien
Pinzas hemostáticas



Lovelace
07-2172-15
15.5cm/6"



Dixon-Lovelace
07-2173-16
16cm/6¼"



Dixon-Lovelace
07-2174-16
16cm/6¼"

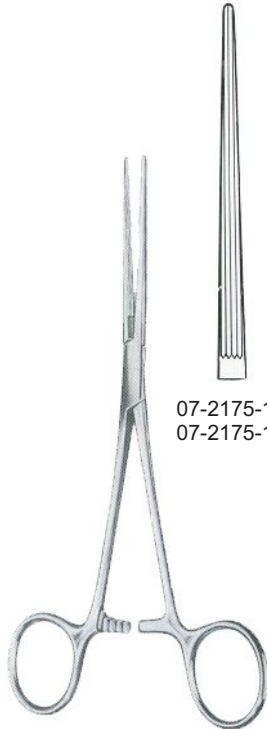

Bainbridge
15cm/6"
18cm/7"



07-2175-15
07-2175-18



07-2176-15
07-2176-18



Fuchsig
07-2177-19
19cm/7½"



Adson
18.5cm/7¼"

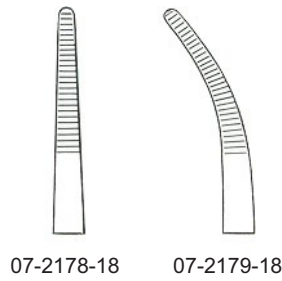

07-2178-18 07-2179-18

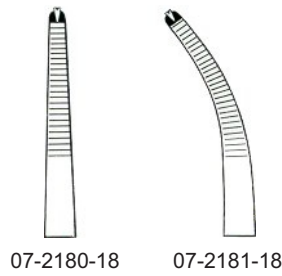

07-2180-18 07-2181-18



Nissen
07-2182-18 18.5cm/7 ¼"
07-2182-22 22.0cm/8 ¾"



Baby-Adson



07-2183-14
14cm/5½"



07-2184-18
18cm/7"

Very Fine

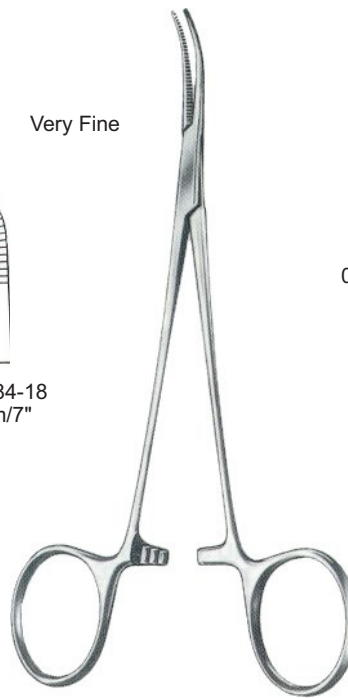

Jacobson-Adson
18cm/7"

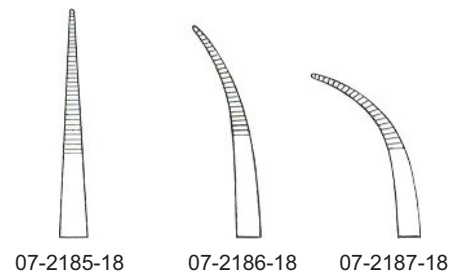

07-2185-18 07-2186-18 07-2187-18



Forceps
 Hemostatic Forceps
 Aterien
 Pinzas hemostáticas

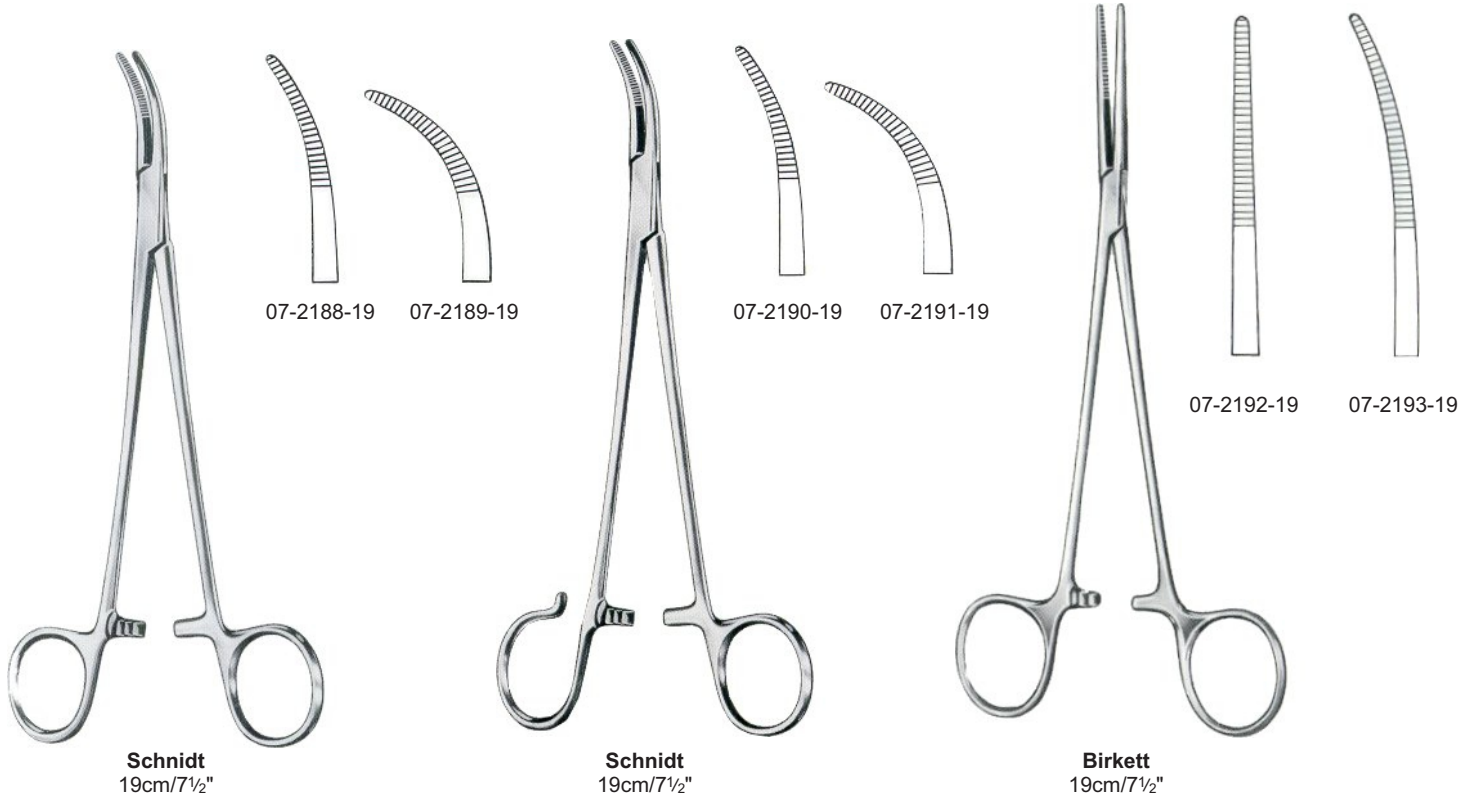

20cm/8"	07-2194-20	07-2195-20	07-2196-20	07-2197-20
22cm/8¾"	07-2194-22	07-2195-22	07-2196-22	07-2197-22
24cm/9½"	07-2194-24	07-2195-24	07-2196-24	07-2197-24
26cm/10¼"	07-2194-26	07-2195-26	07-2196-26	07-2197-26

Bengolea



Bridge
 27cm/10½"

07-2198-27



07-2198-27



Roberts
 22cm/8¾"

07-2199-22



07-2200-22



Kelly



19cm/7½"

07-2201-19

22cm/8¾"

07-2201-22

24cm/9½"

07-2201-24



07-2202-19

07-2202-22

07-2202-24



07-2203-19

07-2203-22

07-2203-24



Forceps

Bronchus And Hemostatic Forceps
Bronchien und Arterienklemmen
Bronquios y hemostáticas Pinzas



Crafoord-Sellors

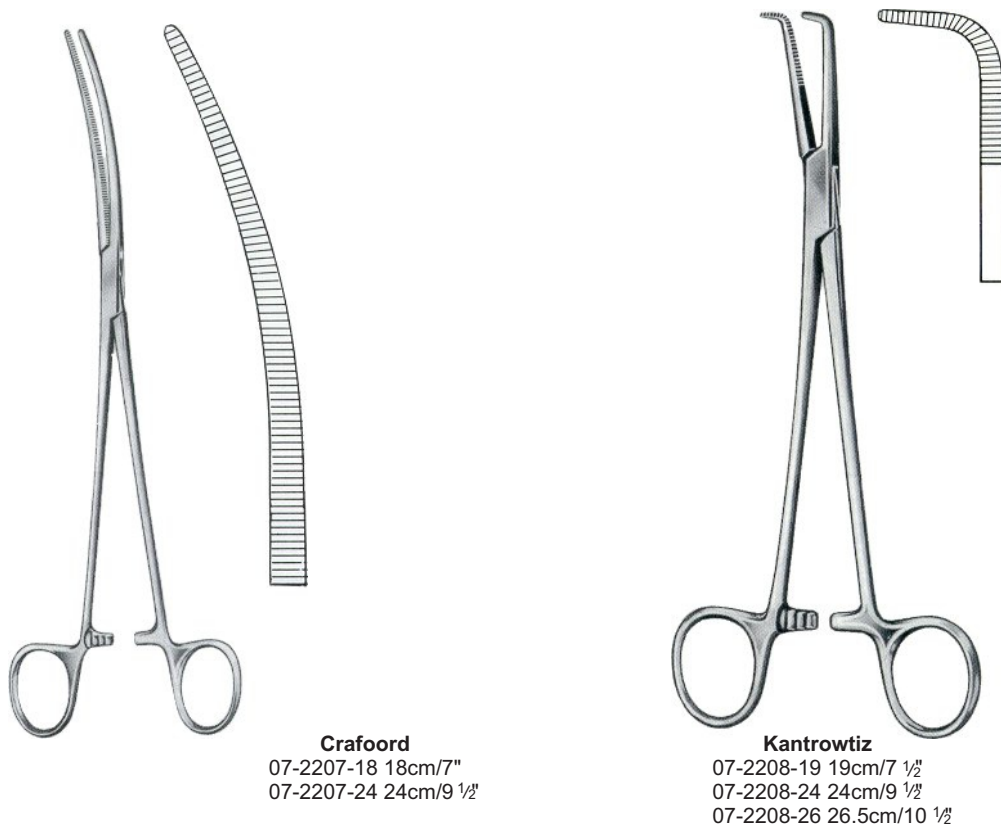



Rumel
 23cm/9"



07-2209-23



07-2210-23



07-2211-23

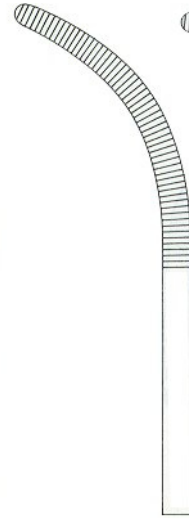

07-2212-23

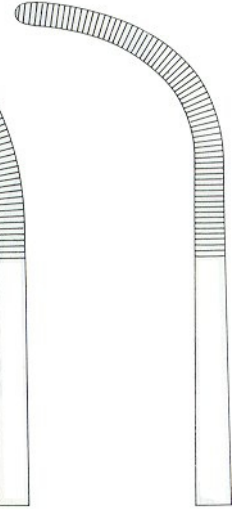

07-2213-23

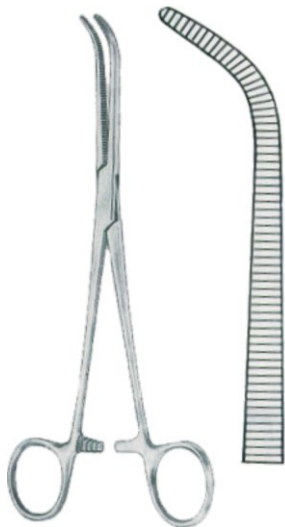

Johns Hopkins
 07-2214-20
 20cm/8"



Zenker
 07-2215-29
 29.5cm/11½"

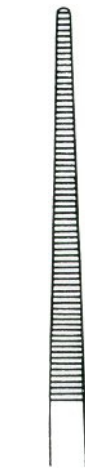

07-2215-29



07-2216-29



07-2217-29

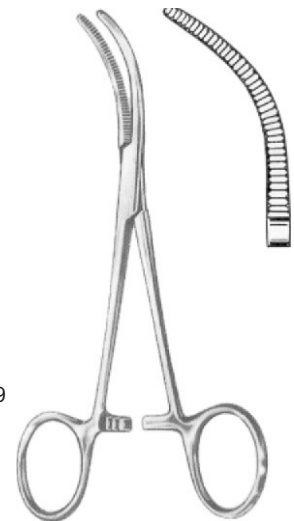

Baby-Overholt
 07-2218-13
 13.5cm/5¼"



Forceps
Dissecting And Ligature Forceps
Präparierscheren Ligaturklemmen
Tijeras para preparaciones ligaduras



Overholt-Slim



07-2219-18
18.5cm/7 1/4"

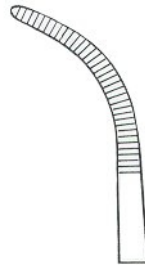

07-2220-20
20.5cm/8"

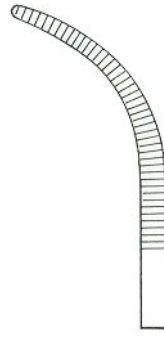

07-2221-21
21cm/8 1/4"

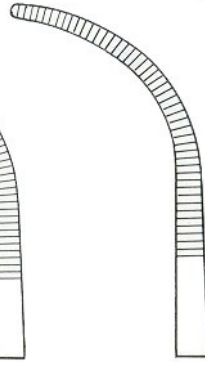

07-2222-21
21.5cm/8 1/2"

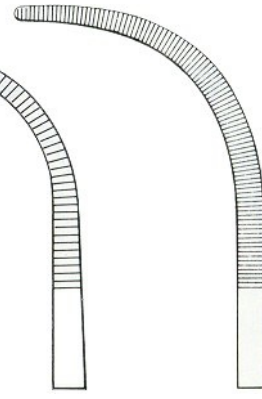

07-2223-24
24cm/9 1/2"



Overholt-Slim



07-2224-18
18.5cm/7 1/4"



07-2225-20
20.5cm/8"

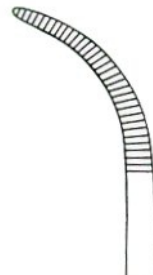

07-2226-21
21cm/8 1/4"

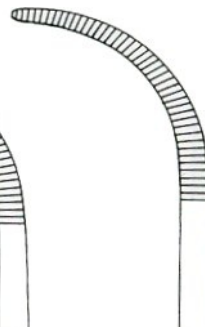

07-2227-21
21.5cm/8 1/4"



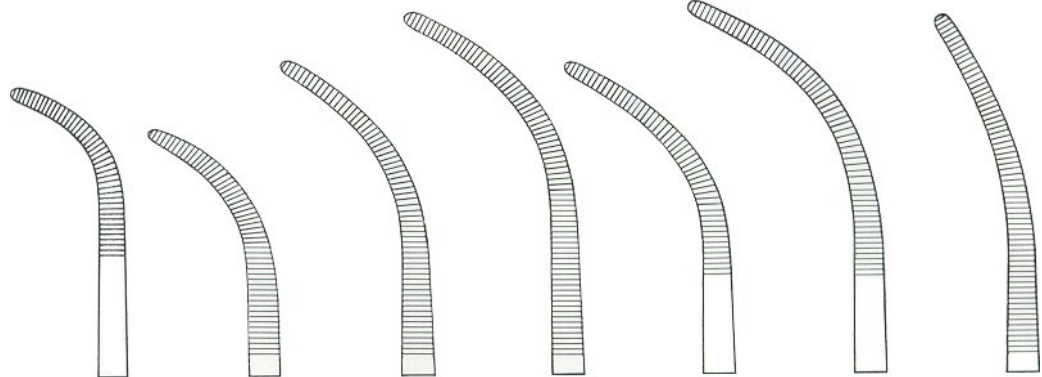

07-2228-21 07-2229-21 07-2230-21 07-2231-21 07-2232-21 07-2233-21 07-2234-21
07-2228-27 07-2229-27 07-2230-27 07-2231-27 07-2232-27 07-2233-27 07-2234-27

Overholt-Geissendorfer
21cm/8¼"
27cm/10½"



Overholt-Mixter
07-2235-21
21cm/8¼"



Heiss
20cm/8"

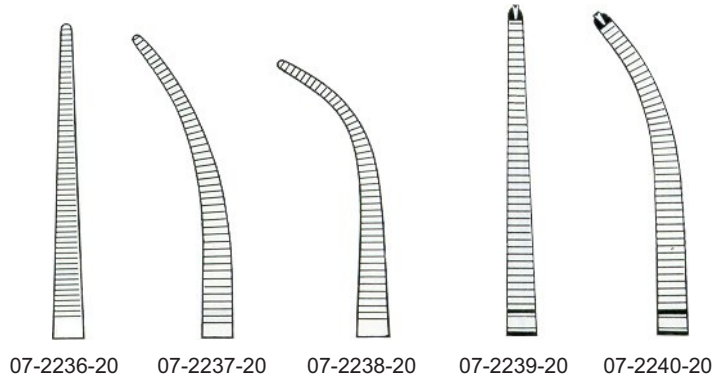

07-2236-20 07-2237-20 07-2238-20 07-2239-20 07-2240-20



Forceps
 Dissecting And Ligature Forceps
 Präparierscheren Ligaturklemmen
 Tijeras para preparaciones ligaduras



Meeker
 07-2241-27
 27 cm/10½"

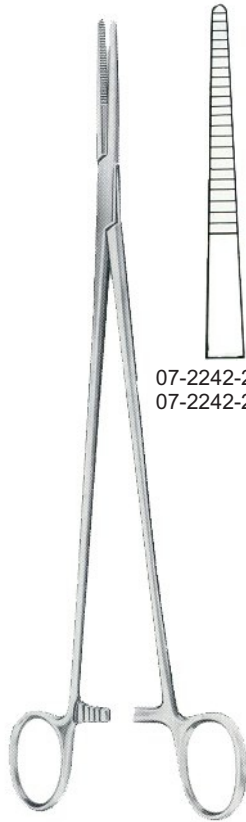

Toennis
 21 cm/8¼"
 26 cm/10¼"

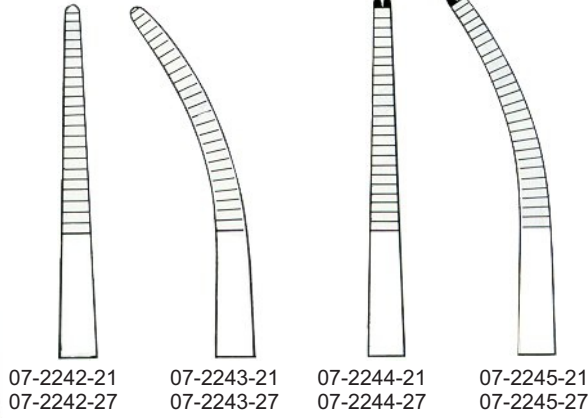

07-2242-21
 07-2242-27
 07-2243-21
 07-2243-27
 07-2244-21
 07-2244-27
 07-2245-21
 07-2245-27



Lower
 07-2246-18
 18 cm/7"



Gemini

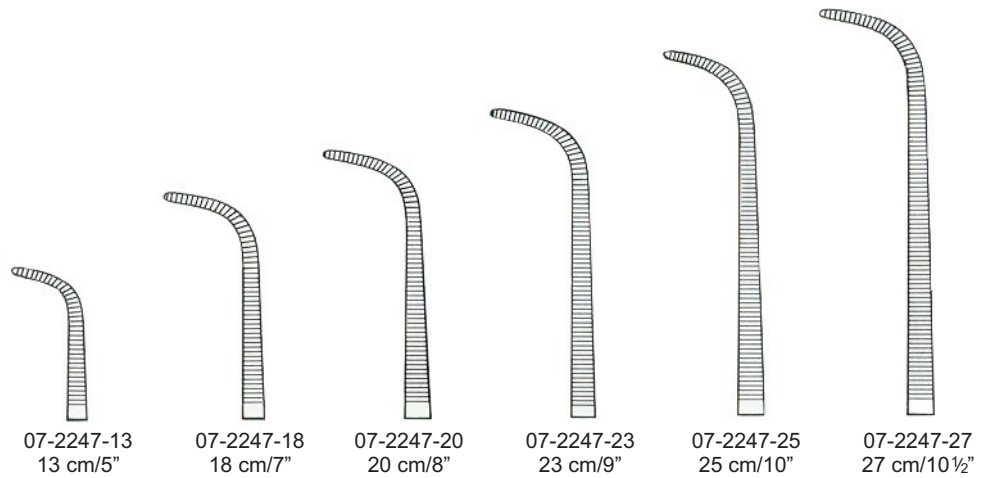

07-2247-13
 13 cm/5"
 07-2247-18
 18 cm/7"
 07-2247-20
 20 cm/8"
 07-2247-23
 23 cm/9"
 07-2247-25
 25 cm/10"
 07-2247-27
 27 cm/10½"



Mini-Gemini

07-2248-18
18 cm/7"

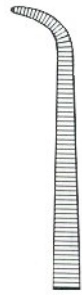

07-2248-22
22 cm/8 3/4"



07-2248-25
25 cm/10"



07-2248-28
28 cm/11"

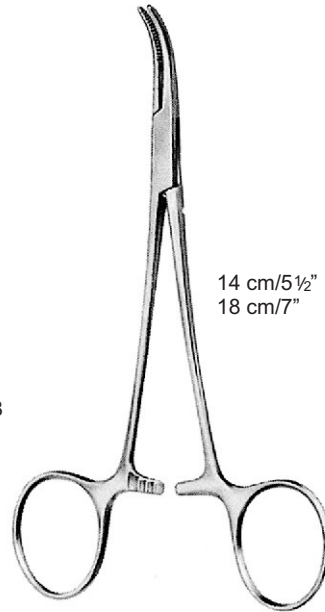

Baby-Mixer

14 cm/5 1/2"
18 cm/7"



07-2249-14
07-2249-18



07-2250-14
07-2250-18



Mixer

07-2251-15 15 cm/6"
07-2251-19 19 cm/7 1/2"

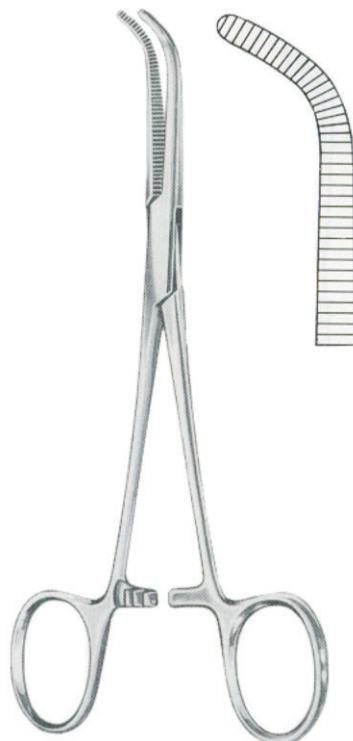

Mixer-O'Shaughnessy

07-2252-15 15.5 cm/6"
07-2252-19 19.0 cm/7 1/2"

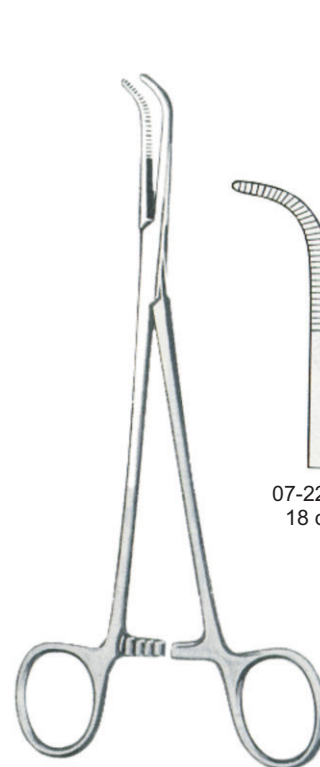

Mixer-Slim

07-2253-18
18 cm/7"



07-2253-23
23 cm/9"



Forceps

Dissecting, Ligature Forceps And Gall Stone Clamps
Präparier- und Ligaturklemmen, Gallenkanalklemmen
Pinzas para preparaciones y ligaduras, Pinzas para conducto biliar



07-2254-22
22 cm/8 3/4"

Mixer



07-2254-22
22 cm/8 3/4"

07-2254-25
25 cm/10"

07-2254-28
28 cm/11"



Mixer
07-2255-22
22 cm/8 3/4"



Wickstroem
07-2256-20
20 cm/8"



Finocchietto
07-2257-24
24 cm/9 1/2"



Mc Quigg-Mixer
07-2258-22
22 cm/8 3/4"



Lawrence
 07-2259-27
 27.5 cm/10¾"



Lahey (Sweet)

07-2260-19
 19 cm/7½"

07-2261-23
 23 cm/9"



Spencer-Wells

- | | | |
|------------|-------------|------------|
| 07-2262-13 | 12.5 cm/5" | 07-2263-13 |
| 07-2262-15 | 15.5 cm/6" | 07-2263-15 |
| 07-2262-18 | 17.75 cm/7" | 07-2263-18 |
| 07-2262-20 | 20 cm/8" | 07-2263-20 |
| 07-2262-23 | 23 cm/9" | 07-2263-23 |



Spencer-Wells

- | | | |
|------------|-------------|------------|
| 07-2264-13 | 12.5 cm/5" | 07-2265-13 |
| 07-2264-14 | 14 cm/5 ½" | 07-2265-14 |
| 07-2264-15 | 15.5 cm/6" | 07-2265-15 |
| 07-2264-18 | 17.75 cm/7" | 07-2265-18 |
| 07-2264-20 | 20 cm/8" | 07-2265-20 |
| 07-2264-23 | 23 cm/9" | 07-2265-23 |



Forceps

Parametrium And Hysterectomy Forceps
 Parametrium Und Hysterektomie Pinzetten
 Parametrio y la histerectomia fórceps



Rogers

07-2266-22
22.5 cm/9"
07-2266-25
25.0 cm/10"



07-2267-22
22.0 cm/8 3/4"
07-2267-24
24.5 cm/9 3/4"

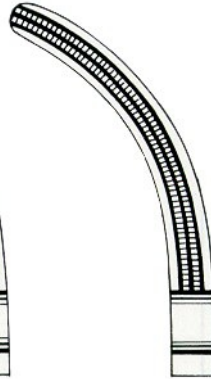

07-2268-21
21.5 cm/8 1/2"
07-2268-24
24.0 cm/9 1/2"

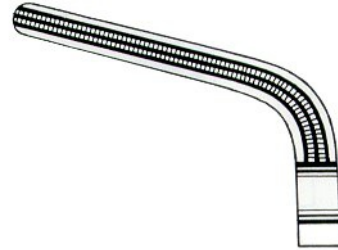

07-2269-20
20.5 cm/8"
07-2269-23
23.5 cm/9"



Heaney

19.5 cm/7 1/2" 07-2270-19
21.5 cm/8 1/4" 07-2270-21
23.5 cm/9" 07-2270-23



07-2271-19
07-2271-21
07-2271-23

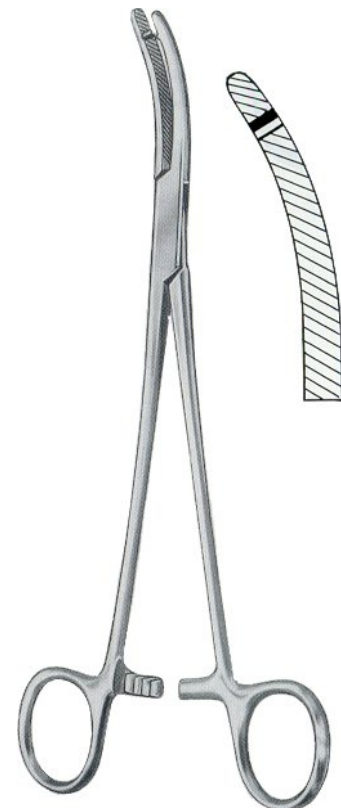

Heaney-Slim
07-2272-21
21 cm/8 1/4"





Ballentine
07-2273-21
21cm/8¼"



Heaney-Ballentine
07-2274-21
21cm/8¼"



Tonsil Forceps

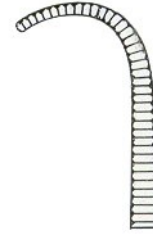

Fig. 1



Fig. 2

Negus
07-2275-19 19cm/7½" 07-2276-19



Phaneuf
21.5cm/8½"



07-2277-21

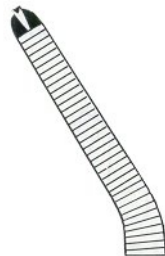

07-2278-21

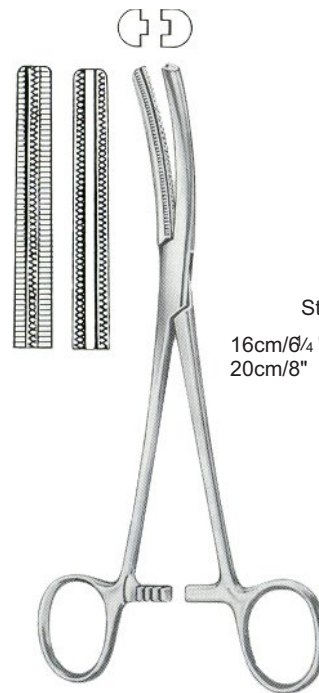

Fergusson

Haemorrhoidal Clamps

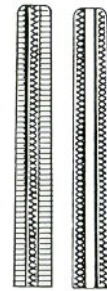

Straight

16cm/6¼" 07-2279-16
20cm/8" 07-2279-20

Curved

07-2280-16
07-2280-20



Forceps

Parametrium And Hysterectomy Forceps
 Parametrium Und Hysterektomie Pinzetten
 Parametrio y la histerectomia fórceps

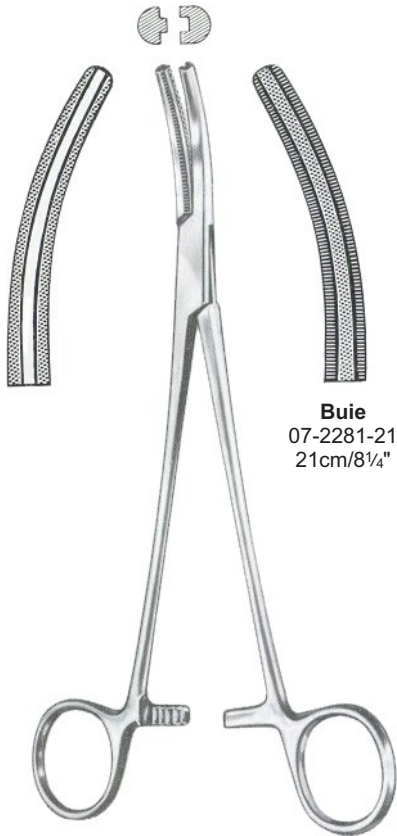

Buie
 07-2281-21
 21cm/8¼"



Long
 07-2282-19
 19cm/7½"



Garland
 07-2283-21
 21cm/8¼"

Gall Duct Clamps

Hysterectomy Forceps

Pressure Clamps

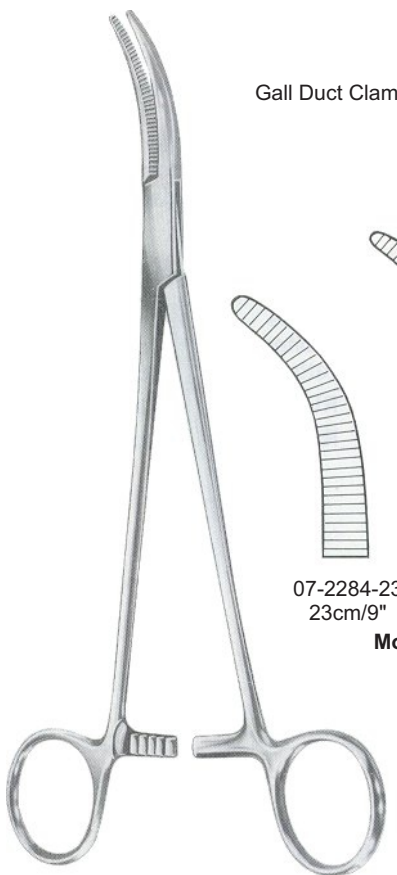

07-2284-23 23cm/9"
 07-2285-24 24cm/9½"
Moynihan



07-2286-23 07-2287-23
Hozlbach
 23.5cm/9¼"



Zweifel
 07-2288-17
 17.5cm/7"



Scalp Flap Forceps

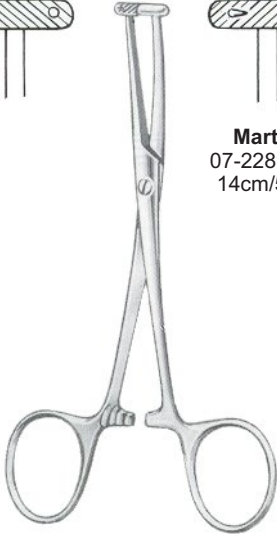

Martel
07-2289-14
14cm/5½"



Wertheim
07-2290-25
25cm/10"

Extra Strong



Wertheim-Cullen
07-2291-21
21.5cm/8½"



Wertheim
07-2292-24
24cm/9½"



Forceps

Hysterectomy Clamp And Vaginal Forceps
Hysterektomieklemmen, Vaginalklemmen
Pinzas-clamps para histerectomía y vaginales

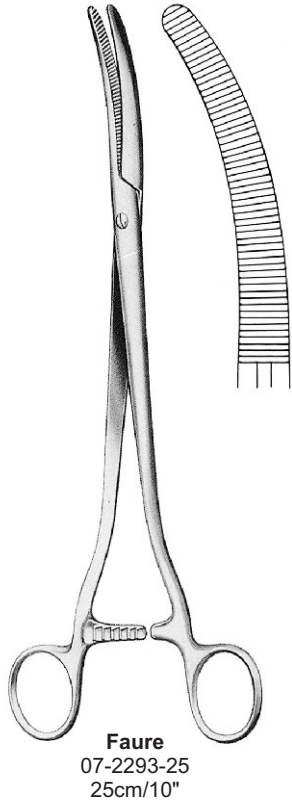

Faure
07-2293-25
25cm/10"



23cm/9"

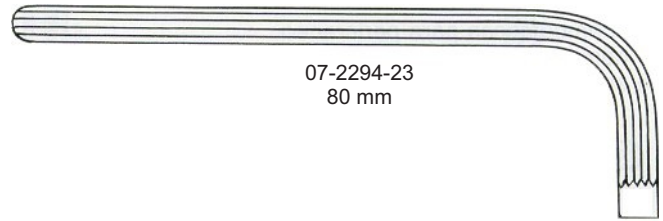

07-2294-23
80 mm

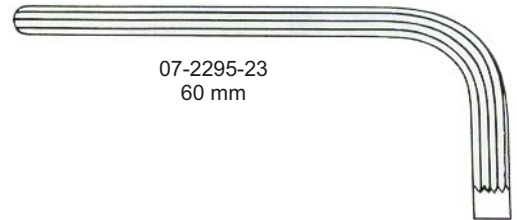

07-2295-23
60 mm



Wertheim
22cm/8 3/4"



Slightly Curved
07-2296-22



More Curved
07-2297-22

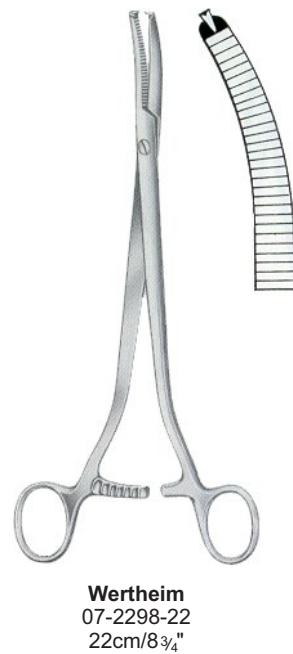

Wertheim
07-2298-22
22cm/8 3/4"



Werheim
 07-2299-18
 18 cm/7"



Baby-Mikulicz
 07-2300-14
 14 cm/5½"



Mikulicz
 07-2301-18 18cm/7"
 07-2301-20 20cm/8"



Mikulicz
 07-2302-20
 20 cm/8"

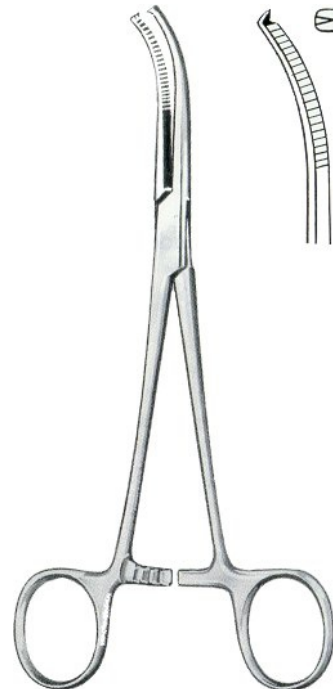

Mikulicz
 07-2303-18
 18.5 cm/7¼"



Forceps

Peritoneal Clamp And Hysterectomy Forceps
Peritoneal Klemme und Hysterektomie Pinzetten
Peritoneal Clamp Y Histerectomía Pinzas

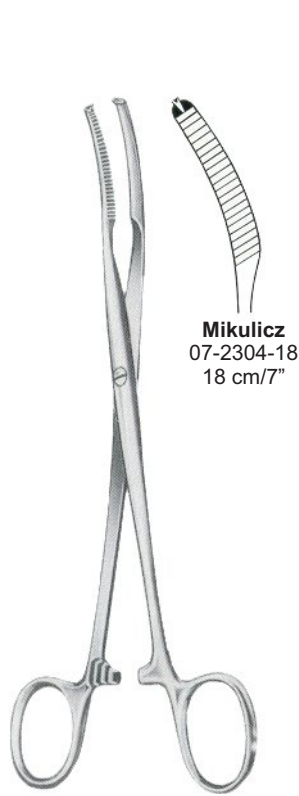

Mikulicz
07-2304-18
18 cm/7"

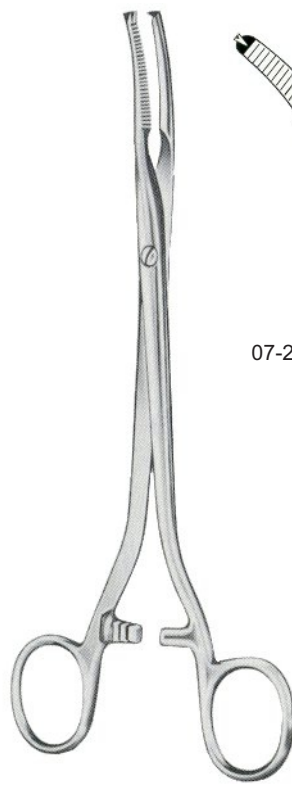

Mikulicz
07-2305-20 20 cm/8" 07-2306-20

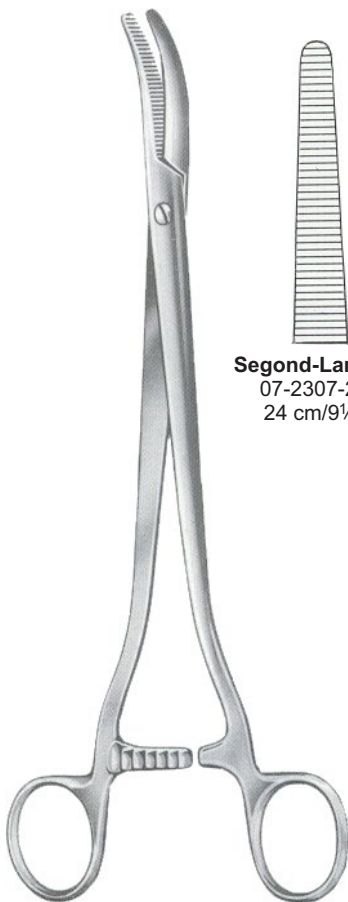
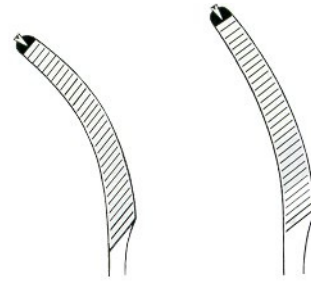

Segond-Landau
07-2307-24
24 cm/9½"



Segond
07-2308-24
24 cm/9½"



Faure
07-2309-20 20 cm/8" 07-2310-20



Schindler
07-2311-20
20 cm/8"





Schadel
07-2312-09
9 cm/3½"



Jones
07-2313-05 5 cm/2"
07-2313-09 9 cm/3 ½"



Engl-Modell
07-2314-09
9 cm/3½"



Backhaus
07-2315-09 9 cm/3 ½"
07-2315-11 11 cm/4 ½"
07-2315-13 13.5 cm/5 ¼"
07-2315-15 16 cm/6 ¼"

With clip for Tubing or Cable



07-2316-11 11 cm/4 ½"
07-2316-13 13 cm/5"



Peers-Bertram
07-2317-14
14.5 cm/5¾"



Tohoku
07-2318-10 10 cm/4"
07-2318-13 13 cm/5"



Forceps
Towel Forceps
Tuchklemme
Pinzas para compresas



Roder
07-2319-13 13 cm/5"
07-2319-15 15 cm/6"



Lorna
07-2320-10 10 cm/4"
07-2320-13 13 cm/5"



Bernhard
07-2321-16 16.5 cm/6 1/2"



Lane
07-2322-20
20 cm/8"



Doyen
07-2323-18
18 cm/7"



07-2324-14 14 cm/5 1/2"
07-2324-15 15 cm/6"
07-2324-18 18 cm/7"
07-2324-20 20 cm/8"

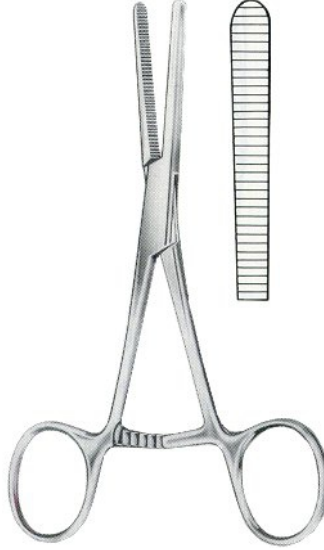

07-2325-14
14.5 cm/5 3/4"

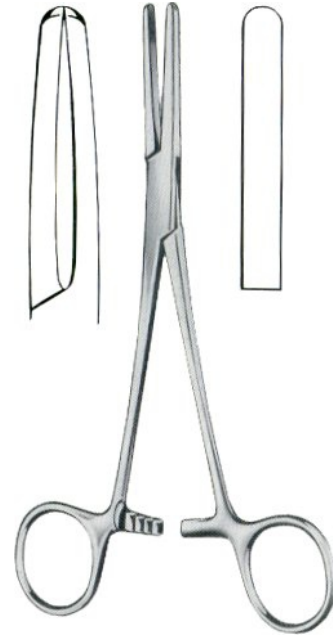

16-04864-16 16.5 cm/6 1/2"
16-04864-18 18.0 cm/7"



07-2326-15 15 cm/6"
07-2326-18 18 cm/7"
07-2326-20 20 cm/8"



Mohr
07-2327-50 50 mm
07-2327-60 60 mm
07-2327-70 70 mm
07-2327-80 80 mm

Sizes
mm
13
17
20
25
30

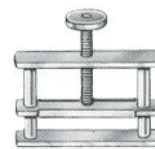

Hoffmann
07-2328-13
07-2328-17
07-2328-20
07-2328-25
07-2328-30



Hoffmann
07-2329-13
07-2329-17
07-2329-20
07-2329-25
07-2329-30



Forceps

Cotton Swab, Polypus And Dressing Forceps
 Wattestäbchen, Polypus Und Pinzette
 Esponja de algodón, pólipo y pinzas Dressing



Ulrich

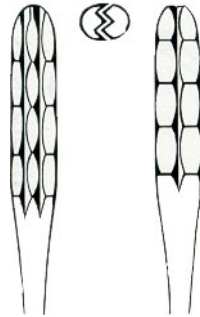

Straight

- 07-2330-22
- 07-2330-25
- 07-2330-27

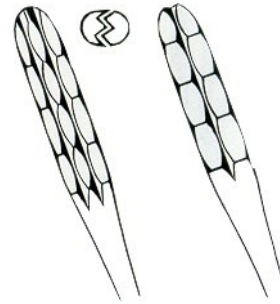

Curved

- 22 cm/8³/₄"
- 25 cm/10"
- 27 cm/10¹/₂"

- 07-2331-22
- 07-2331-25
- 07-2331-27



Lister

- | | | |
|------------|----------|------------|
| 07-2332-13 | 13 cm/5" | 07-2333-13 |
| 07-2332-15 | 15 cm/6" | 07-2333-15 |
| 07-2332-18 | 18 cm/7" | 07-2333-18 |



Bryant

- 07-2334-13
- 13 cm/5"

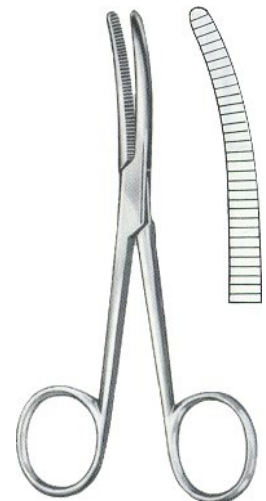

Bryant

- 07-2335-13
- 13 cm/5"



Gross-Maier



Straight

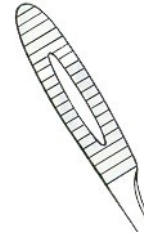

Curved

With Ratchet

07-2336-20	20 cm/8"	07-2337-20
07-2336-25	25 cm/10"	07-2337-25

Without Ratchet

07-2338-20	20 cm/8"	07-2339-20
07-2338-25	25 cm/10"	07-2339-25



Pelkman
25 cm/10"



07-2340-25



07-2341-25

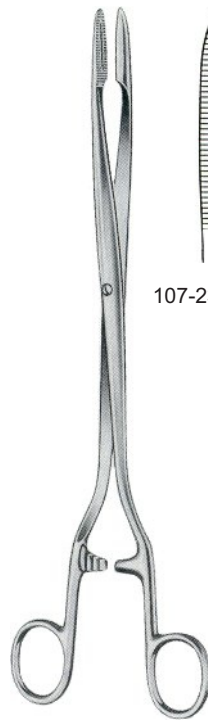

Sims-Maier
28 cm/11"



107-2342-28



07-2343-28



Duplay
20 cm/8"



07-2344-20



07-2345-20



Forceps
Cotton Swab Forceps
Tupferzangen
Esponja de algodón Pinzas

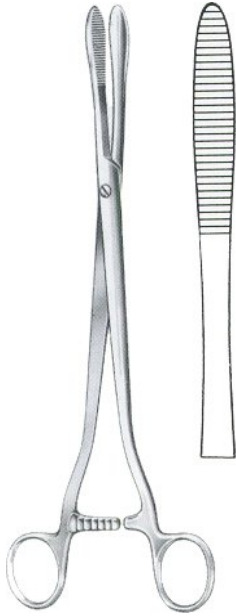

Collin
07-2346-25
25cm/10"

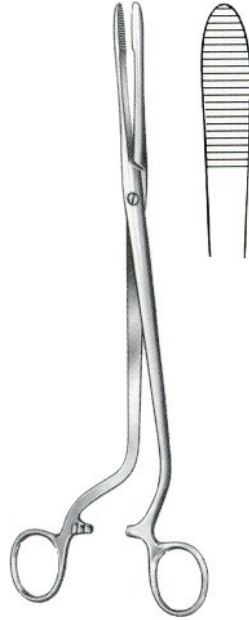

Cheron
07-2347-25
25cm/10"



Emmet
07-2348-21
21cm/8 1/4"



Bozemann
07-2349-26
26cm/10 1/4 "



Bozemann
26cm/10 1/4 "



07-2350-26



07-2351-26

Smooth

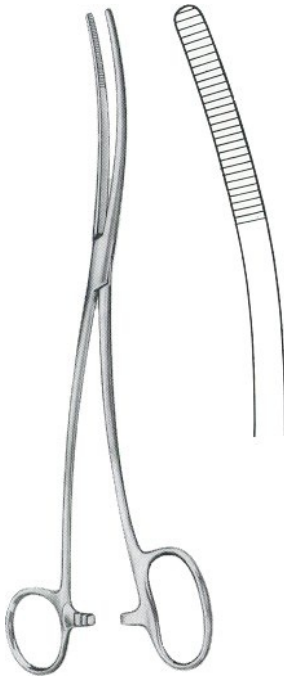

Bozemann-Douglas
 07-2352-26
 26cm/10¼"

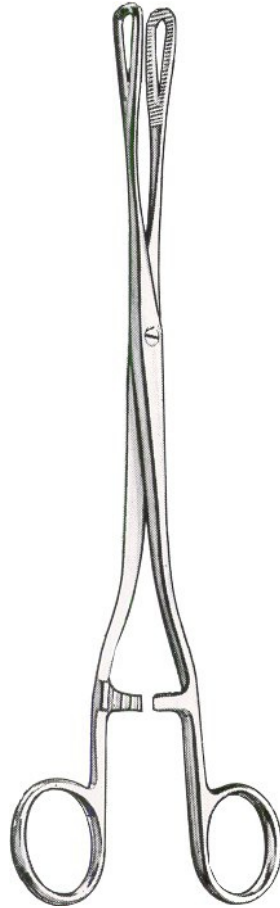

Rampley
 07-2353-18 18cm/7"
 07-2353-24 24cm/9 ½"



Rampley
 07-2354-18 18cm/7"
 07-2354-24 24cm/9 ½"



Foerster

18 cm/7"
 20 cm/8"
 24 cm/9 ½"
 25 cm/10"



07-2355-18
 07-2355-20
 07-2355-24
 07-2355-25

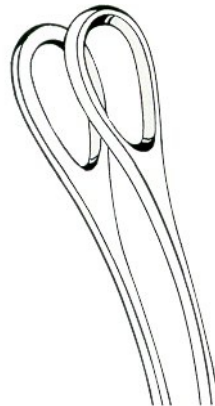

07-2356-18
 07-2356-20
 07-2356-24
 07-2356-25



07-2357-18
 07-2357-20
 07-2357-24
 07-2357-25

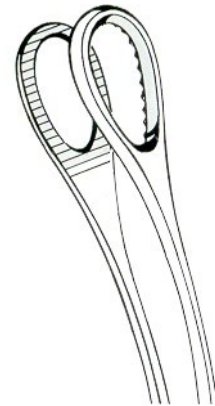

07-2358-18
 07-2358-20
 07-2358-24
 07-2358-25



Forceps
Bulldog Clamps
Bulldogklemmen
Clamps Bulldog



Schwartz
07-2359-19
19cm/7½"



07-2360-01



07-2360-02



07-2360-03

Applying Forceps



07-2361-23
23cm/9"



Diethrich

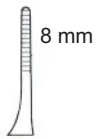

07-2362-08

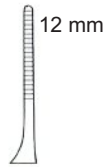

07-2362-12



07-2362-20



07-2363-08

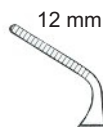

07-2363-12

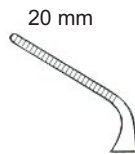

07-2363-20

Atrauma



07-2364-10



07-2364-14



07-2364-20



07-2365-10



07-2365-14



07-2365-20

