



**13**

**EN**

**Bone Surgery**

**DE**

**Knochenchirurgie**

**ES**

**Cirugía ósea**

**Page 247 to 316**



BONE SURGERY

Mallets  
Hämmer  
Martillos y Mazos



**Mead**  
13-3301-17 17.0cm  
26mm Ø,320 g (11¼ oz)

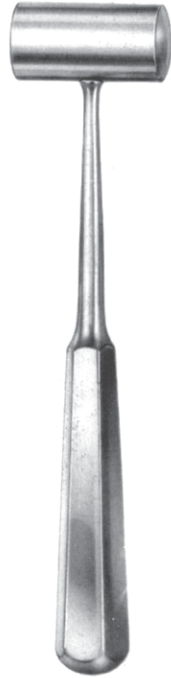

**Parsch**  
13-3302-18 18.0cm  
22mm Ø,200 g (7 oz)

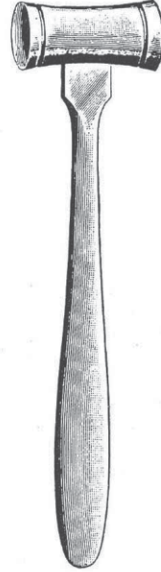

13-3303-30  
30mm Ø,510 g

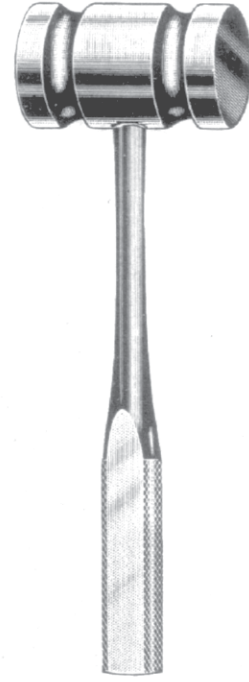

13-3304-25 250 g  
13-3305-45 450 g  
13-3306-90 900 g  
26.5cm

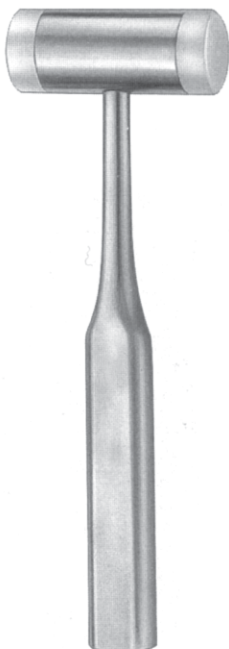

13-3307-18 18.5cm  
25mm Ø 135 g



lead filled

13-3308-19 19.0cm  
22mm Ø 155 g



**Hajek**  
13-3309-22 22.0cm  
27mm Ø 130 g

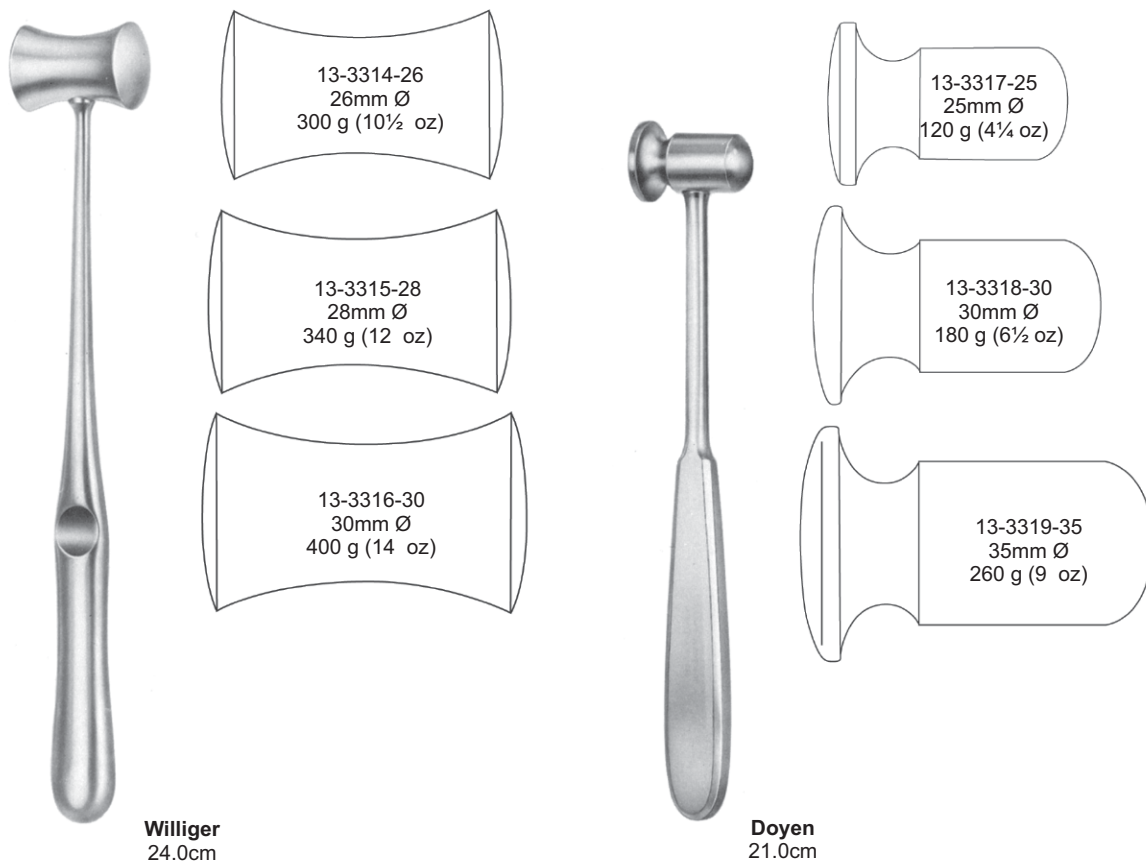
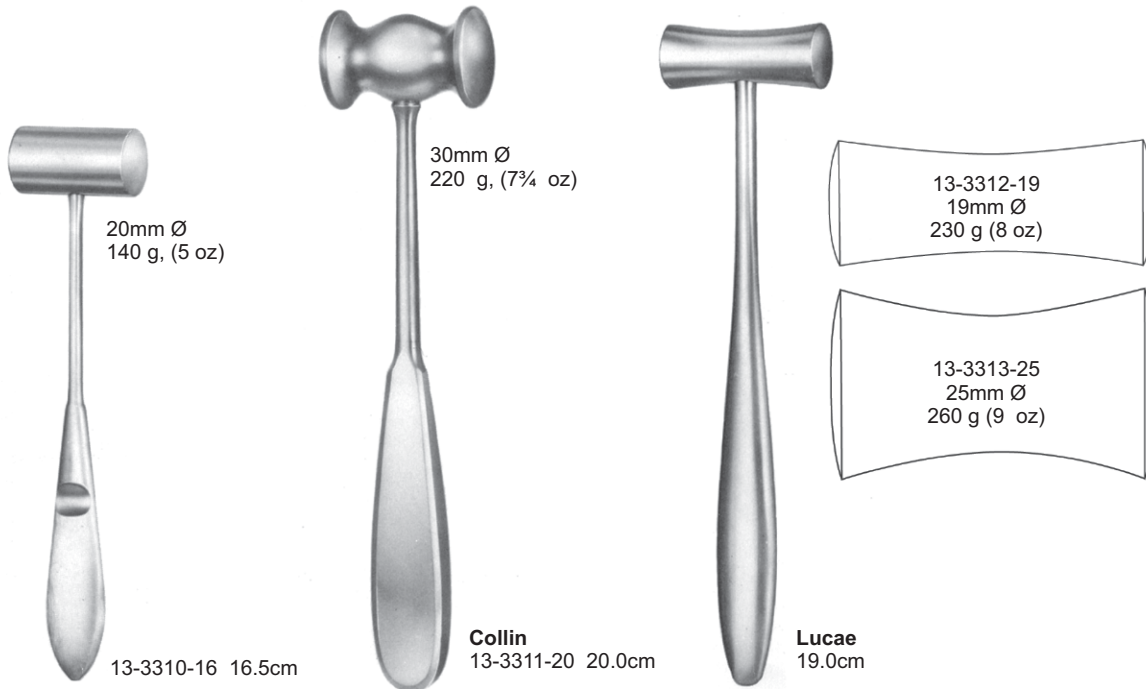

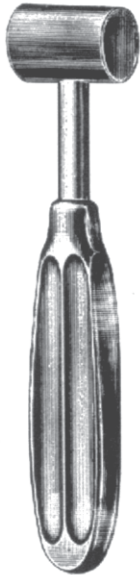

**Gerzog**  
13-3320-18 18.0cm  
250 g

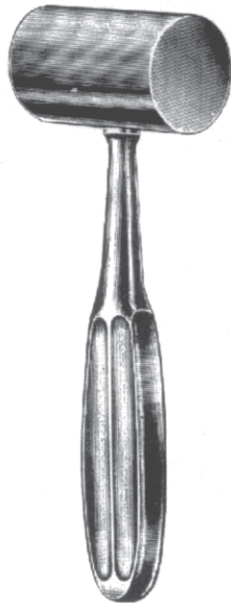

**Kirk**  
13-3321-19 19.0cm  
750 g

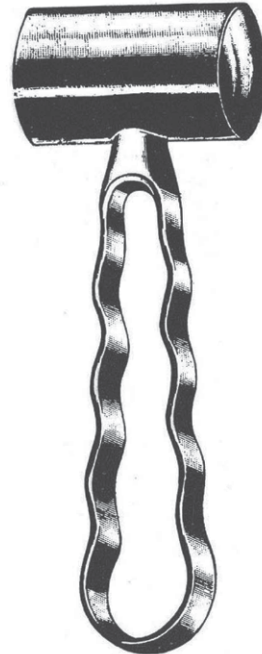

**Heath**  
18.0cm  
13-3322-35 35mm Ø (28 oz)  
13-3322-40 40mm Ø (36 oz)



42mm Ø      30mm Ø  
13-3323-26  
26.5cm 530 g (19 oz)

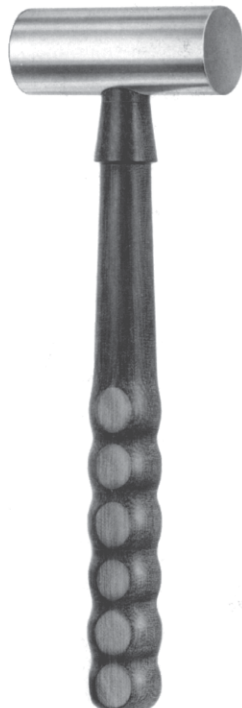

13-3324-24  
24.0cm (30mm Ø 480 g)



13-3325-22  
22.5cm (37mm Ø 370 g)



13-3326-24 24.0cm





13-3327-26 26.5cm  
30mm Ø, 510 g (18 oz)



13-3328-26 26.5cm



13-3329-25 26.5cm 250 g (0.55 lbs)  
13-3329-45 26.5cm 450 g (1 lbs)  
13-3329-90 26.5cm 900 g (2 lbs)



mm  
02 13-3330-02  
03 13-3330-03  
04 13-3330-04  
05 13-3330-05  
06 13-3330-06  
07 13-3330-07  
08 13-3330-08  
13.5 cm/5¼"

**Partsch**

13-3331-02  
13-3331-03  
13-3331-04  
13-3331-05  
13-3331-06  
13-3331-07  
13-3331-08  
17 cm/6¾"

mm  
04 13-3333-04  
06 13-3333-06  
08 13-3333-08  
10 13-3333-10  
12 13-3333-12  
14 13-3333-14  
16 13-3333-16  
17cm/6¾"

**Partsch**

Width

mm  
04 13-3334-04 13-3335-04 13-3336-04  
06 13-3334-06 13-3335-06 13-3336-06  
08 13-3334-08 13-3335-08 13-3336-08  
10 13-3334-10 13-3335-10 13-3336-10  
12 13-3334-12 13-3335-12 13-3336-12  
14 13-3334-14 13-3335-14 13-3336-14  
16 13-3334-16 13-3335-16 13-3336-16  
13.5 cm/5¼"



13-3340-03  
3mm  
13-3340-05  
5mm  
13-3340-07  
7mm  
213-3340-09  
9mm

16 cm/6¼"



13-3341-02  
2.5mm  
13-3341-03  
3.5mm

mm  
06 13-3337-06  
12 13-3337-12  
18 13-3337-18

**Mod. USA**  
13-3338-06  
13-3338-12  
13-3338-18  
16 cm/6¼"

13-3339-06  
13-3339-12  
13-3339-18

**Passow**  
12 cm/4¾"



**Lexer**  
 27.5 cm/10¾"

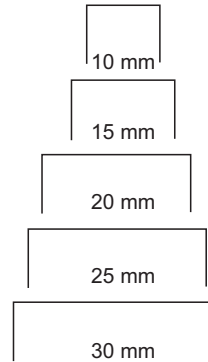

13-3342-10  
 13-3342-15  
 13-3342-20  
 13-3342-25  
 13-3342-30



13-3343-10  
 13-3343-15  
 13-3343-20  
 13-3343-25  
 13-3343-30



**Cloward**  
 24 cm/9½"

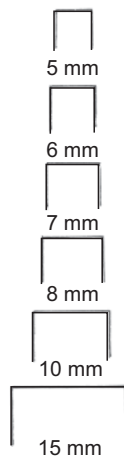

13-3344-05  
 13-3344-06  
 13-3344-07  
 13-3344-08  
 13-3344-10  
 13-3344-15



13-3345-05  
 13-3345-06  
 13-3345-07  
 13-3345-08  
 13-3345-10  
 13-3345-15



**Alexander**  
18 cm/7"

	mm	
13-3346-04	04	13-3347-04
13-3346-06	06	13-3347-06
13-3346-08	08	13-3347-08
13-3346-10	10	13-3347-10
13-3346-12	12	13-3347-12
13-3346-14	14	13-3347-14

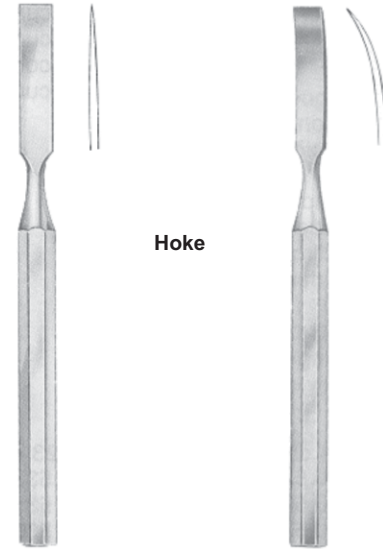

**Hoke**

14 cm/5½"

	mm	
13-3348-02	2	13-3349-02
13-3348-03	3	13-3349-03
13-3348-04	4	13-3349-04
13-3348-05	5	13-3349-05
13-3348-06	6	13-3349-06
13-3348-07	7	13-3349-07
13-3348-08	8	13-3349-08



**Smith-Petersen**  
20 cm/8"



mm				
06	13-3350-06	13-3351-06	13-3352-06	13-3353-06
09	13-3350-09	13-3351-09	13-3352-09	13-3353-09
13	13-3350-13	13-3351-13		
14			13-3352-14	13-3353-14
16	13-3350-16	13-3351-16	13-3352-16	13-3353-16
19	13-3350-19	13-3351-19	13-3352-19	13-3353-19
25	13-3350-25	13-3351-25	13-3352-25	13-3353-25
32	13-3350-32	13-3351-32	13-3352-32	13-3353-32



**Lambotte**

	mm	
13-3354-04	04	13-3355-04
13-3354-06	06	13-3355-06
13-3354-08	08	13-3355-08
13-3354-10	10	13-3355-10
13-3354-13	13	13-3355-13
13-3354-16	16	13-3355-16
13-3354-18	18	13-3355-18
13-3354-20	20	13-3355-20
13-3354-25	25	13-3355-25
13-3354-30	30	13-3355-30
13-3354-38	38	13-3355-38
13-3354-44	44	13-3355-44
13-3354-50	50	13-3355-50

24 cm/9½"

Curved



**Mini-Lambotte**

	mm	
13-3356-02	02	13-3357-02
13-3356-03	03	13-3357-03
13-3356-04	04	13-3357-04
13-3356-06	06	13-3357-06
13-3356-08	08	13-3357-08
13-3356-10	10	13-3357-10
13-3356-12	12	13-3357-12
13-3356-15	15	13-3357-15
	12.5 cm/5"	17 cm/6¾"



**Mini-Lexer**

	mm	
13-3358-04	04	13-3359-04
13-3358-06	06	13-3359-06
13-3358-08	08	13-3359-08
13-3358-10	10	13-3359-10
13-3358-12	12	13-3359-12

18 cm/7"



**Lexer**

	mm	
13-3360-05	05	13-3361-05
13-3360-07	07	13-3361-07
13-3360-10	10	13-3361-10
13-3360-15	15	13-3361-15
13-3360-20	20	13-3361-20
13-3360-25	25	13-3361-25
13-3360-30	30	13-3361-30

22 cm/8¾"







**Chisel**  
13-3362-20  
24.5 cm/9¾"  
20 mm



**Chisel-Curved**  
13-3363-20  
26.5 cm/10½"  
20 mm

Gouge for the  
removing of  
broken screws



13-3364-22  
22 cm/8¾"



**Zielke**  
 23 cm/9"  
 5.5 mm  
 9.0 mm

13-3365-05  
 13-3365-09



Width

mm	13-3366-06	13-3367-06	13-3368-06	13-3369-06	13-3370-06
06	13-3366-06	13-3367-06	13-3368-06	13-3369-06	13-3370-06
08	13-3366-08	13-3367-08	13-3368-08	13-3369-08	13-3370-08
10	13-3366-10	13-3367-10	13-3368-10	13-3369-10	13-3370-10
12	13-3366-12	13-3367-12	13-3368-12	13-3369-12	13-3370-12
15	13-3366-15	13-3367-15	13-3368-15	13-3369-15	13-3370-15
20	13-3366-20	13-3367-20	13-3368-20	13-3369-20	13-3370-20
25	13-3366-25	13-3367-25	13-3368-25	13-3369-25	13-3370-25
30	13-3366-30	13-3367-30	13-3368-30	13-3369-30	13-3370-30

**Stille**  
 20 cm/8"



mm	13-3371-06	13-3372-06	13-3373-06	13-3374-06	13-3375-06
06	13-3371-06	13-3372-06	13-3373-06	13-3374-06	13-3375-06
09	13-3371-09	13-3372-09	13-3373-09	13-3374-09	13-3375-09
13	13-3371-13	13-3372-13	13-3373-13	13-3374-13	13-3375-13
16	13-3371-16	13-3372-16	13-3373-16	13-3374-16	13-3375-16
19	13-3371-19	13-3372-19	13-3373-19	13-3374-19	13-3375-19
25	13-3371-25	13-3372-25	13-3373-25	13-3374-25	13-3375-25
32	13-3371-32	13-3372-32	13-3373-32	13-3374-32	13-3375-32

**Hibbs**  
 24 cm/9½"



**BONE SURGERY**  
 Bone Chisels and Gauges  
 Meißel und Osteotome  
 Cinceles y Gubias para huesos



mm **Lexer**  
 05 13-3376-05  
 10 13-3376-10  
 15 13-3376-15  
 28 cm/11"



**Lexer**  
 13-3377-05  
 13-3377-10  
 13-3377-15  
 25 cm/10"



**Lexer**  
 13-3378-05  
 13-3378-10  
 13-3378-15  
 25 cm/10"



13-3379-01



13-3379-02



13-3379-03



**Cobb**  
 28 cm/11"

13-3379-04



**Putti**  
 13-3380-30  
 30 cm/12"



**Putti**  
 13-3381-27  
 27 cm/10½"



13-3382-25  
 25 cm/10"



13-3383-24  
 24 cm/9½"



13-3384-22  
 22 cm/8¾"



Width

**Lambotte**  
 21 cm/8¼"

- |            |    |
|------------|----|
|            | mm |
| 13-3385-05 | 05 |
| 13-3385-10 | 10 |
| 13-3385-15 | 15 |
| 13-3385-20 | 20 |
| 13-3385-25 | 25 |



**Schneider**  
 13-3386-17  
 13 mm  
 17.5 cm/7"



**Schneider-Sauerbruch**  
 13-3387-19  
 13 mm  
 19 cm/7½"



**Alexander**  
 13-3388-20  
 20 cm/8"



**Jansen**  
 13-3389-16  
 15 mm  
 16.5 cm/6½"



**Seldin**  
 13-3390-19  
 19 cm/7½"



**Davidson-Alexander**  
 13-3391-29  
 29 cm/11½"

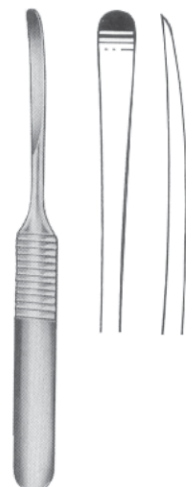

**Williger**  
 13-3392-29  
 13 cm/5"



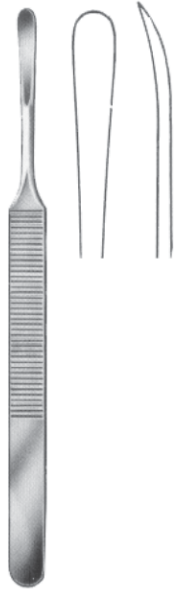

**König**  
 13-3393-15  
 15.5 cm/6"  
 5 mm

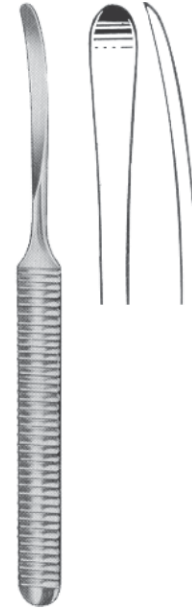

**Williger**  
 13-3394-16  
 16 cm/6¼"



**Adson**  
 17 cm/6¾"



13-3395-01



13-3395-02



13-3395-03



13-3395-04



13-3396-06  
 6 mm

17 cm/6¾"

13-3397-08  
 8 mm



**Farabeuf**  
 13-3398-15  
 15 cm/6"



**Farabeuf**  
 13-3399-15  
 15 cm/6"



**Farabeuf-Collin**  
 13-3400-15  
 15.5 cm/6"  
 11 mm



**Farabeuf-Collin**  
 13-3401-15  
 15.5 cm/6"  
 11 mm



**Farabeuf**  
 13-3402-19  
 19 cm/7½"  
 13 mm

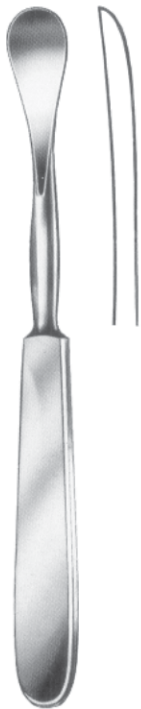

**Sedillot**  
 13-3403-18  
 18 cm/7"  
 18 mm



**Sedillot**  
 13-3404-21  
 21 cm/8¼"  
 15 mm



**Langenbeck**  
 13-3405-19  
 19 cm/7½"



**Langenbeck**  
 13-3406-18  
 18 cm/7"



**Overholt**  
 13-3407-29  
 29.5 cm/11½"



**Overholt**  
 13-3408-29  
 29.5 cm/11½"



**Overholt**  
 13-3409-28  
 28.5 cm/11¼"



**Hylin**  
 14.5 cm/5¾"



13-3410-01



13-3410-02



13-3410-03



**Matson**  
 13-3411-22  
 22 cm/8¾"



**BONE SURGERY**  
 Periosteal Raspatories  
 Raspatorien  
 Legras-Periostótomos



**Semb**



13-3412-01  
 19.5 cm/7½"  
 12 mm

13-3413-02  
 19.5 cm/7½"  
 12 mm

13-3414-03  
 19.5 cm/7½"  
 12 mm

13-3415-04  
 22 cm/8¾"  
 13 mm

13-3416-05  
 21.5 cm/8½"  
 13 mm

13-3417-06  
 22 cm/8½"  
 15 mm

13-3418-07  
 22 cm/8½"  
 15 mm



**Doyen**  
 17 cm/6¾"

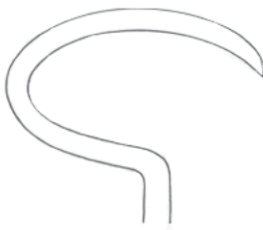

13-3419-01

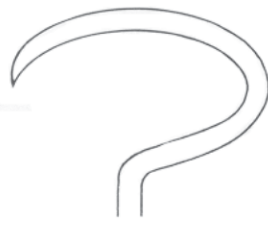

13-3419-02



13-3420-01



13-3420-02



13-3421-01



**Doyen**  
 24 cm/9½" 13-3422-02



13-3423-04  
4 mm



13-3423-06  
6 mm



13-3423-08  
8 mm



**Cobb**  
24 cm/9½"



13-3423-10  
10 mm



13-3423-13  
13 mm



13-3423-19  
19 mm



13-3423-25  
25 mm





**BONE SURGERY**  
Periosteal Raspatories  
Raspatorien  
Legras-Periostótomos



13-3424-01  
19 cm/7½"  
6 mm



13-3425-02  
18.5 cm/7¼"  
3 mm



13-3426-03  
18.5 cm/7¼"  
6 mm



13-3427-04  
18.5 cm/7¼"  
6 mm

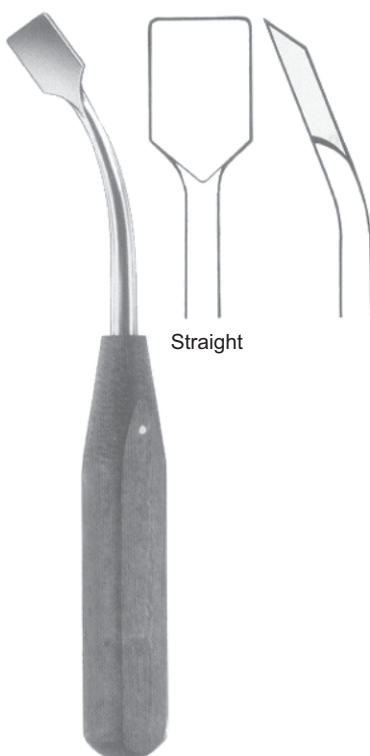

13-3428-05  
18.5 cm/7¼"  
13 mm



13-3429-06  
19.5 cm/7¾"  
14 mm



13-3430-07  
18.5 cm/7¼"  
14 mm

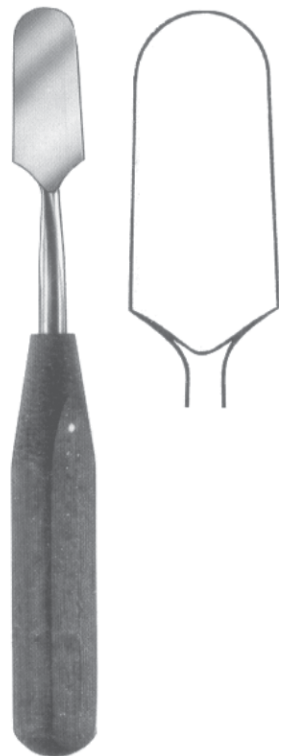

13-3431-08  
20 cm/8"  
20 mm



13-3432-20  
 27.5 cm/10<sup>3</sup>/<sub>4</sub>"  
 20 mm



**Wagner**  
 8 mm 13-3433-08 33 cm/13"  
 17 mm 13-3433-17 33 cm/13"



**Cobb**  
 10 mm 13-3434-10 25 cm/10"  
 13 mm 13-3434-13 25 cm/10"  
 19 mm 13-3434-19 25 cm/10"  
 25 mm 13-3434-25 25 cm/10"



**Cobb**  
 10 mm 13-3435-10 28 cm/11"  
 13 mm 13-3435-13 28 cm/11"  
 19 mm 13-3435-19 28 cm/11"



**BONE SURGERY**

Elevators  
Elevatoren  
Elevadores



**Hoen**

13-3436-07  
16 cm/6¼"  
7 mm

13-3436-15  
18.5 cm/7¼"  
15 mm

13-3436-20  
19 cm/7½"  
20 mm



**Yankauer**  
13-3437-18  
18 cm/7"



**Langenbeck**  
13-3438-20  
20 cm/8"  
8 mm



**Langenbeck**  
13-3439-20  
20 cm/8"  
10 mm



**Langenbeck**  
13-3440-23  
23 cm/9"  
11 mm



**Mass. Gen. Hosp.**  
13-3441-15  
15 cm/6"



**Williger**  
13-3442-17  
17 cm/6¾"  
5.5 mm



**Williger**  
13-3443-16  
16 cm/6¼"



**Quervain**  
13-3444-20  
20 cm/8"



13-3445-16  
16 cm/6 1/4"

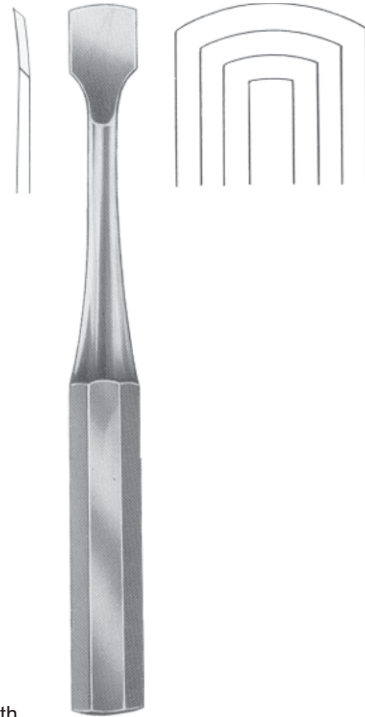

Width  
**Key**  
6 mm 13-3446-06 19 cm/7 1/2"  
12 mm 13-3446-12 19 cm/7 1/2"  
19 mm 13-3446-19 19 cm/7 1/2"  
25 mm 13-3446-25 19 cm/7 1/2"



**Konig**  
13-3447-15  
15 cm/6"  
4.5 mm



**Konig**  
13-3448-15  
15 cm/6"  
4.5 mm



**Alderdyce**  
13-3449-21  
21 cm/8 1/4"

**McDonald**  
13-3450-19  
19 cm/7 1/2"

**Watson-Cheyne**  
13-3451-19  
17.5 cm/7"



**Sebileau**  
13-3452-17  
17 cm/6 3/4"



**BONE SURGERY**

Elevators  
Elevatoren  
Elevadores



13-3453-14  
14 cm/5½"  
2.8 mm



13-3454-15  
15 cm/6"  
5 mm



13-3455-15  
15 cm/6"  
7 mm

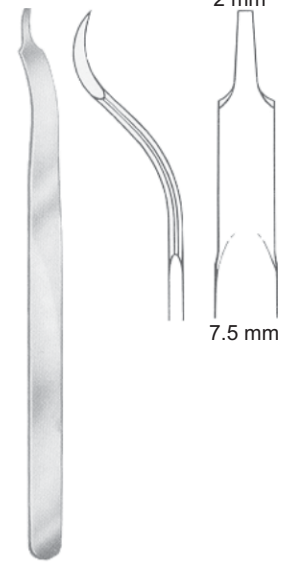

**Buck-Graccko**  
13-3456-15  
15 cm/6"

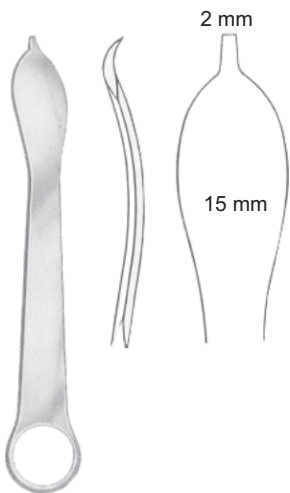

13-3457-12  
12.5 cm/5"



**Mini-Hohmann**  
16 cm/6¼"



13-3458-06  
6 mm



13-3458-08  
8 mm



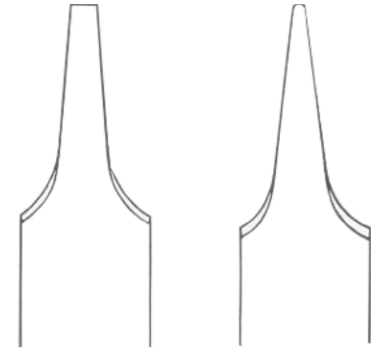

13-3459-17  
17 mm

13-3460-17  
17 mm



13-3461-26  
26.5 cm/10½"  
24 mm



**Lange-Hohmann**  
13-3462-26  
26 cm/10¼"  
22 mm



**Hohmann**  
13-3463-22  
22 cm/8¾"  
8 mm



**Hohmann**  
13-3464-24  
24 cm/9½"  
14mm

**BONE SURGERY**

Bone Levers  
Knochenhebel  
Elevadores para huesos



**Hohmann**  
13-3465-26  
26 cm/10¼"  
22 mm

**Hohmann**  
13-3466-28  
28 cm/11"  
33 mm

**Hohmann**  
13-3467-24  
24 cm/9½"  
43 mm

**Hohmann**  
13-3468-24  
24.5 cm/9¾"  
43 mm

**Hohmann**  
13-3469-24  
24 cm/9½"  
70 mm

**Hohmann**  
13-3470-22  
22 cm/8¾"  
18 mm



**Lange-Hohmann modif**  
 30 mm 13-3471-26 26.5 cm/10½"  
 33 mm 13-3471-29 29.0 cm/11½"

**Hohmann-Aldinger**  
 13-3472-27  
 27 cm/10½"

**Schumacher**  
 (Wagner)  
 13-3473-34  
 34.5 cm/13½"

**Schumacher**  
 13-3474-29  
 29 cm/11½"



**BONE SURGERY**

Bone Levers  
Knochenhebel  
Elevadores para huesos



**Smillie**  
14 cm/5½"

13-3475-01  
32x19 mm

13-3475-02  
48x19 mm

13-3475-03  
57x19 mm



13-3475-04  
52x13 mm



13-3475-05  
12x13 mm

Spinal retractors



13-3476-01  
75x30 mm

13-3476-02  
100x30 mm

**Taylor**  
17 cm/6½"



13-3477-21  
21.5 cm/8½"

Meniscus retractors



**Blount**  
13-3478-17  
17.5 cm/7"



**Murphy-Lane**  
 13-3479-32  
 32 cm/12½"



**Chandler**

Length	Width	
18 cm	13 mm	13-3480-13
20 cm	19 mm	13-3480-19
23 cm	25 mm	13-3480-23
25 cm	30 mm	13-3480-30



**Blount**  
 13-3481-26  
 26 cm/10¼"



**Blount**  
 13-3482-26  
 26 cm/10¼"



**Bennett**    13-3483-44    44 mm  
 24 cm/9½"    13-3483-64    64 mm



**BONE SURGERY**  
Meniscotomy Knives  
Meniskotome  
Bisturios para meniscos



**Smillie**  
13-3484-17  
17 cm/6¾"



**Smillie**  
13-3485-17  
17 cm/6¾"



**Smillie**  
13-3486-17  
17 cm/6¾"



**Salenius**  
13-3487-22  
22 cm/8¾"



**Salenius**  
13-3488-22  
22 cm/8¾"

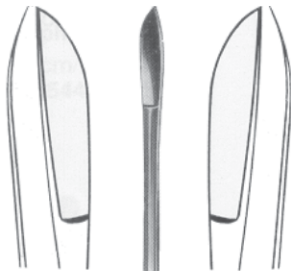

13-3489-17  
17.5 cm/7"



**Neff**  
13-3490-21  
21.5 cm/8½"



13-3491-01 **Canad-Modell**  
20 cm/8"



13-3492-02



**Bircher**  
13-3493-20  
20.5 cm/8"



Drill guide and dura protecting forceps



**Adson**  
 13-3494-15  
 15 cm/6"

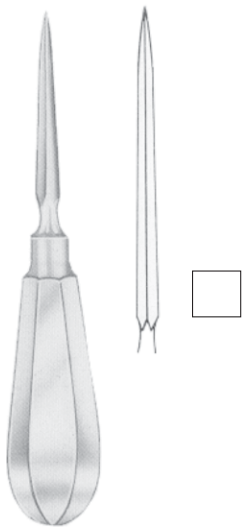

13-3495-14  
 14 cm/5 1/2"



**Perthes**  
 13-3496-21  
 21 cm/8 1/4"

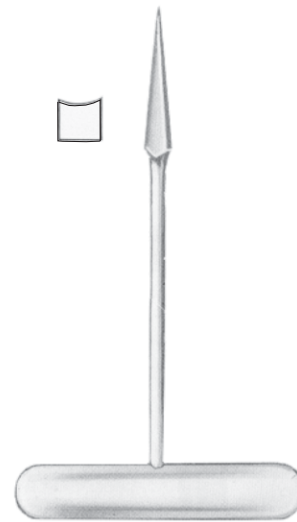

13-3497-14  
 14 cm/5 1/2"





**Stille**  
20.0cm  
13-3498-00 compl. set  
13-3498-20 drill only

13-3498-01 2.5mm Ø	13-3498-02 3.0mm Ø	13-3498-03 3.5mm Ø	13-3498-04 4.0mm Ø	13-3498-05 10.0mm Ø	13-3498-06 5.0mm Ø
13-3498-07 8.0mm Ø	13-3498-08 12.0mm Ø	13-3498-09 16.0mm Ø	13-3498-10 1.0mm Ø	13-3498-11 1.5mm Ø	13-3498-12 2.0mm Ø

13-3499-00 compl. set  
13-3499-01 drill only

13-3499-09 9.0cm 3.2mm Ø	13-3499-07 7.0cm 3.2mm Ø

13-3499-08  
Set of drills

**Jacobs**  
13-3500-00 6.35mm

13-3501-00 set

13-3502-00 set



**Stille-Sherman**  
24.0cm

13-3503-00 compl. set  
13-3503-24 drill only



13-3503-25  
2.5mm Ø



13-3503-30  
3.0mm Ø



13-3503-35  
3.5mm Ø



**Hudson**  
13-3504-00  
13-3504-27

compl. set / 6  
(13-3504,01,  
02,03,07,09)  
handle only



13-3504-01  
9mm Ø



13-3504-02  
14mm Ø



13-3504-03  
16mm Ø



13-3504-04  
22mm Ø



**Cushing**  
13-3504-05  
14mm Ø



13-3504-06  
2mm Ø



**Mckenzie**  
13-3504-07  
13mm Ø



**Errico**  
13-3504-08  
16mm Ø



13-3504-09

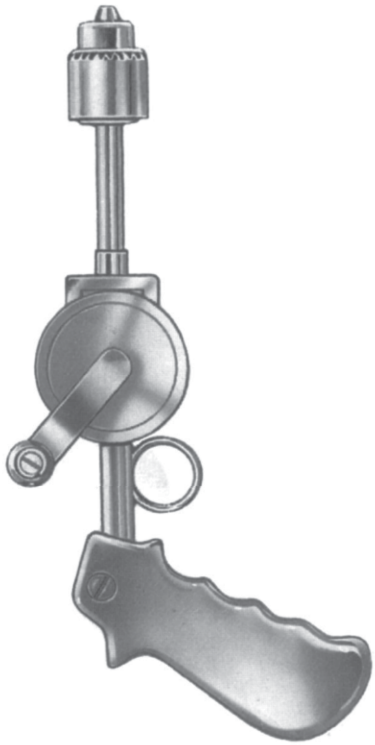

13-3505-00



13-3506-00



13-3507-00

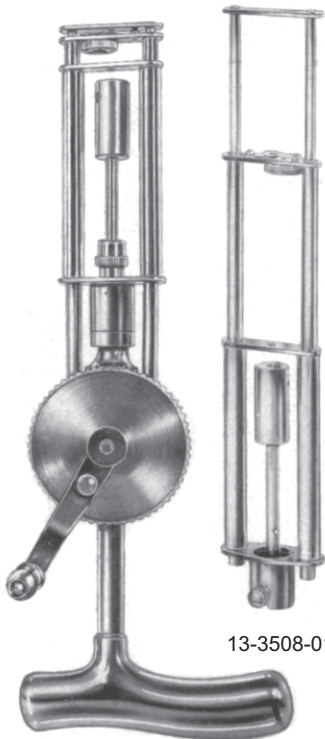

13-3508-01

13-3508-00 complete set



13-3509-01

13-3509-02



13-3509-03

**Kirschner**  
13-3509-00 complete set

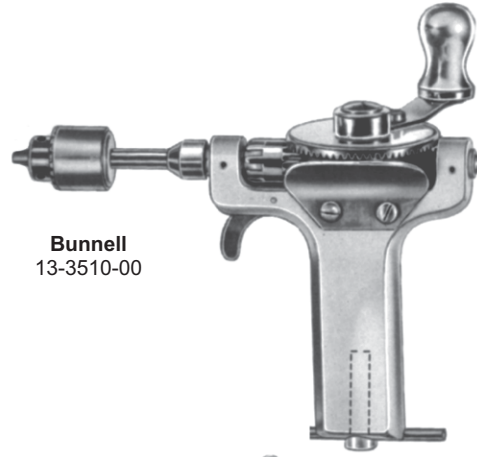

**Bunnell**  
13-3510-00



**Ralk**  
13-3511-00

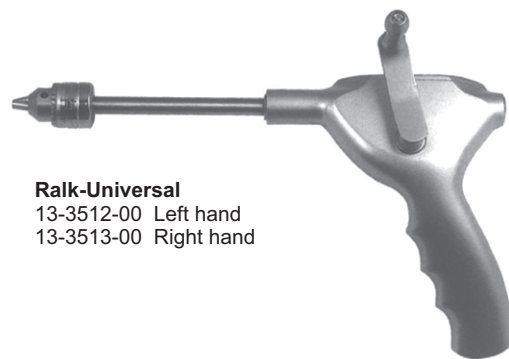

**Ralk-Universal**  
13-3512-00 Left hand  
13-3513-00 Right hand

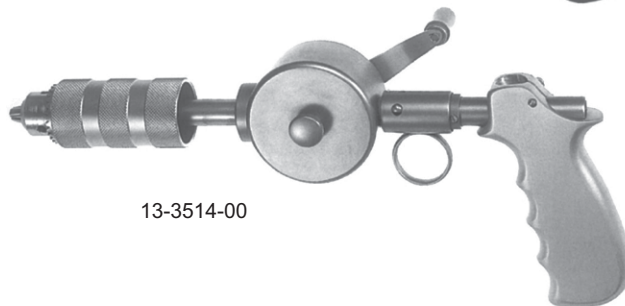

13-3514-00



**BONE SURGERY**  
 Amputating and Resection Saws  
 Amputations- und Resektionssägen  
 Sierras para amputación y resección



**Spare Saw Blade**  
 13-3515-12 12mm  
 13-3515-15 15mm  
 13-3515-18 18mm



**Charriere**  
 13-3515-35 35.0cm



**Spare Saw Blade**  
 13-3516-03 3mm  
 13-3516-05 5mm  
 13-3516-07 7mm

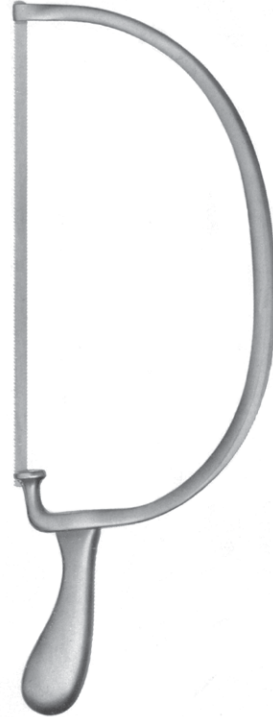

**Helferich-Bier**  
 13-3516-39 39.0cm



**Lindemann**  
 13-3517-20 20.0cm



**Langenbeck**  
 13-3518-23 23.0cm

13-3519-06 6mm  
 13-3519-08 8mm  
 13-3519-12 12mm  
 13-3519-15 15mm  
 13-3519-18 18mm



**Rust**  
 13-3519-39 39.0cm



**Charriere**  
 13-3520-27 27.0cm  
 13-3520-30 30.0cm  
 13-3520-34 34.0cm



**Satterlee**  
 13-3521-31 31.0cm



**Charriere**  
 13-3522-27 27.0cm  
 13-3522-30 30.0cm



**Satterlee**  
 13-3523-31  
 31.0cm

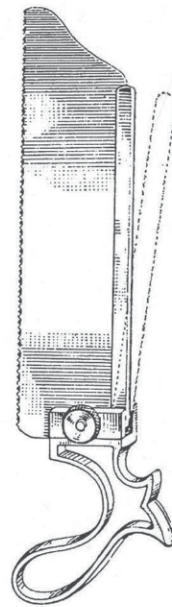

13-3524-23  
 23.0cm

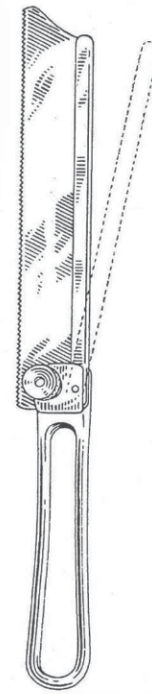

13-3525-19  
 19.0cm



**BONE SURGERY**

Bone Curettes  
Scharfe Löffel  
Cucharillas cortantes

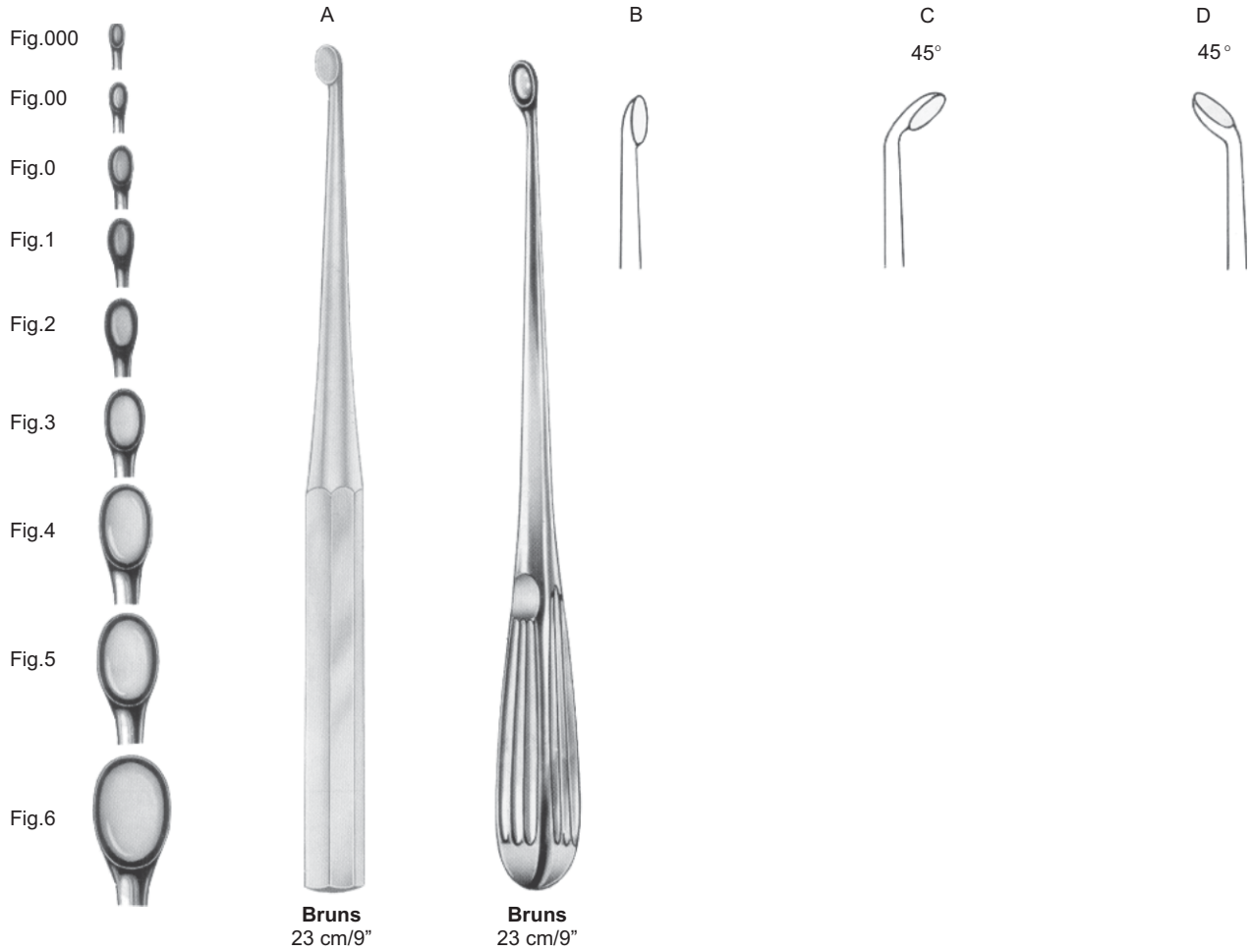
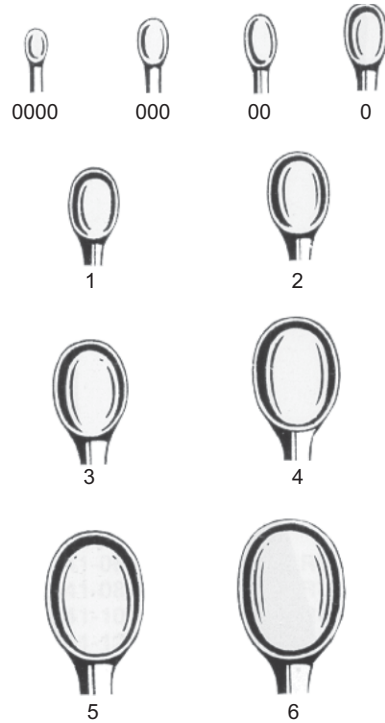

Fig.	A	B	C	D
000	13-3526-30	13-3527-30	13-3528-30	13-3529-30
00	13-3526-20	13-3527-20	13-3528-20	13-3529-20
0	13-3526-10	13-3527-10	13-3528-10	13-3529-10
1	13-3526-01	13-3527-01	13-3528-01	13-3529-01
2	13-3526-02	13-3527-02	13-3528-02	13-3529-02
3	13-3526-03	13-3527-03	13-3528-03	13-3529-03
4	13-3526-04	13-3527-04	13-3528-04	13-3529-04
5	13-3526-05	13-3527-05	13-3528-05	13-3529-05
6	13-3526-06	13-3527-06	13-3528-06	13-3529-06





**Volkmann**  
 17 cm/6¾"



- Fig.  
 0000 13-3530-40  
 000 13-3530-30  
 00 13-3530-20  
 0 13-3530-10  
 1 13-3530-01  
 2 13-3530-02  
 3 13-3530-03  
 4 13-3530-04  
 5 13-3530-05  
 6 13-3530-06



**Volkmann**  
 17 cm/6¾"

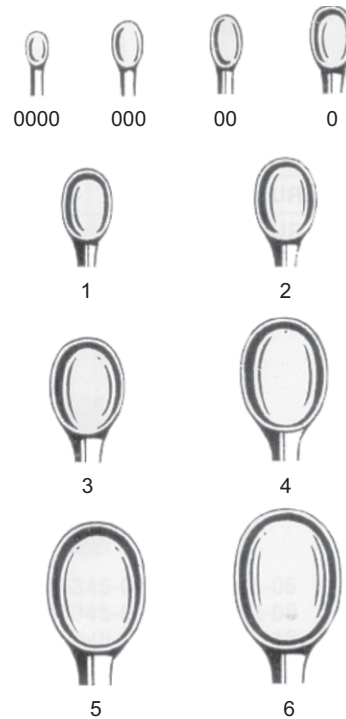

- Fig.  
 0000 13-3531-40  
 000 13-3531-30  
 00 13-3531-20  
 0 13-3531-10  
 1 13-3531-01  
 2 13-3531-02  
 3 13-3531-03  
 4 13-3531-04  
 5 13-3531-05  
 6 13-3531-06



13-3532-21  
 21 cm/8 1/4"



**Epstein**



**Spinal**



**Spinal**

Fig.	13-3533-30	13-3534-30	13-3535-30
000	13-3533-30	13-3534-30	13-3535-30
00	13-3533-20	13-3534-20	13-3535-20
0	13-3533-10	13-3534-10	13-3535-10
1	13-3533-01	13-3534-01	13-3535-01
2	13-3533-02	13-3534-02	13-3535-02
3	13-3533-03	13-3534-03	13-3535-03
4	13-3533-04	13-3534-04	13-3535-04
5	13-3533-05	13-3534-05	13-3535-05
6	13-3533-06	13-3534-06	13-3535-06
	20 cm/8"	20 cm/8"	20 cm/8"



	<b>Volkmann</b>	<b>Volkmann</b>	
Length	Oval/Oval	Oval/Round	
cm			
in			
13	5"	13-3536-13	13-3537-13
14	5½"	13-3536-14	
16	6¼"		13-3537-16
17	6¾"	13-3536-17	
20	8"	13-3536-20	13-3537-20



**Martini**  
13.5 cm/5"



**Jansen**  
13-3539-15  
15 cm/6"



**Jansen**  
13-3540-16  
16 cm/6¼"



**Williger**  
13.5 cm/5"



**Jacobson**  
13-3542-13  
13 cm/5"



**Janson**  
13-3543-15  
15 cm/6"



**Barth**  
13-3544-18  
18 cm/7"



**BONE SURGERY**

Bone Curettes  
Scharfe Löffel  
Cucharillas cortantes



**Schede**  
17 cm/6¾"

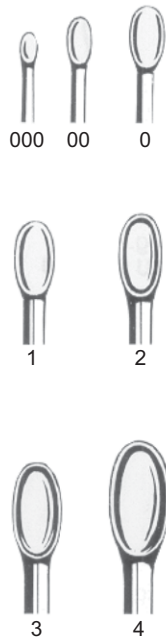
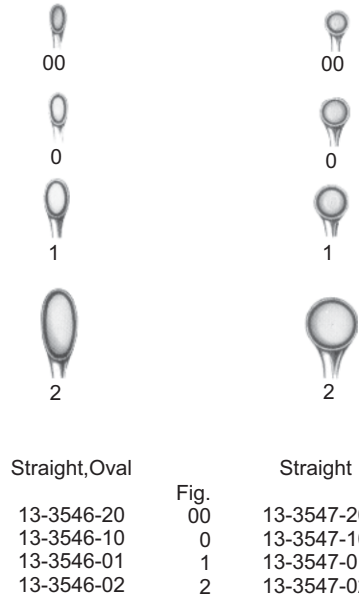

Fig.	
000	13-3545-30
00	13-3545-20
0	13-3545-10
1	13-3545-01
2	13-3545-02
3	13-3545-03
4	13-3545-04



**Williger**  
17.5 cm/7"



Straight, Oval	
13-3546-20	
13-3546-10	
13-3546-01	
13-3546-02	

Straight	
Fig.	
00	13-3547-20
0	13-3547-10
1	13-3547-01
2	13-3547-02

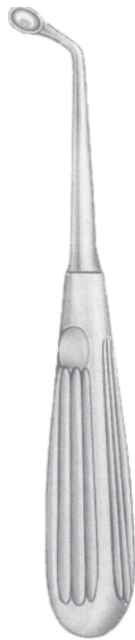

13-3548-01

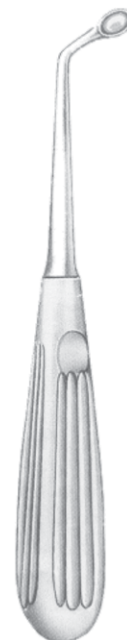

13-3549-02

**Uffendorde**  
17 cm/6¾"

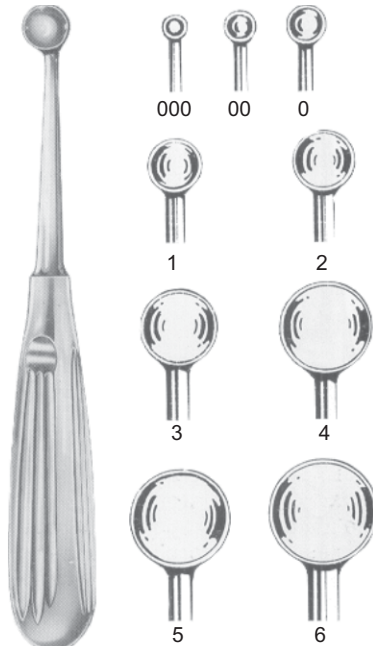

**Bruns**  
17 cm/6<sup>3</sup>/<sub>4</sub>"

<b>Bruns</b>	<b>Fig.</b>	<b>Spratt</b>
13-3550-30	000	13-3551-30
13-3550-20	00	13-3551-20
13-3550-10	0	13-3551-10
13-3550-01	1	13-3551-01
13-3550-02	2	13-3551-02
13-3550-03	3	13-3551-03
13-3550-04	4	13-3551-04
13-3550-05	5	13-3551-05
13-3550-06	6	13-3551-06

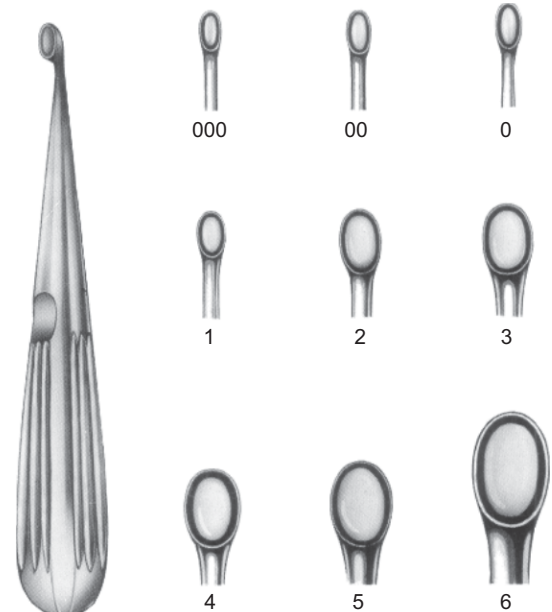

**Spratt**  
16 cm/6<sup>1</sup>/<sub>4</sub>"



**Swedish pattern**

mm	Round	Oval
2	13-3552-02	13-3553-02
3	13-3552-03	13-3553-03
4	13-3552-04	13-3553-04
5	13-3552-05	13-3553-05
6	13-3552-06	13-3553-06
7	13-3552-07	13-3553-07
8	13-3552-08	13-3553-08
10	13-3552-10	13-3553-10
12	13-3552-12	13-3553-12
14	13-3552-14	13-3553-14
	17cm/6 <sup>3</sup> / <sub>4</sub> "	22cm/8 <sup>1</sup> / <sub>2</sub> "



**BONE SURGERY**

Bone Curettes  
Scharfe Löffel  
Cucharillas cortantes



Flexible

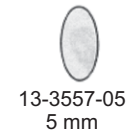
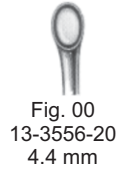
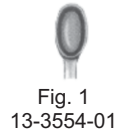

**Halle**  
21 cm/8¼"



25 cm/10"



**Bushe**  
25 cm/10"

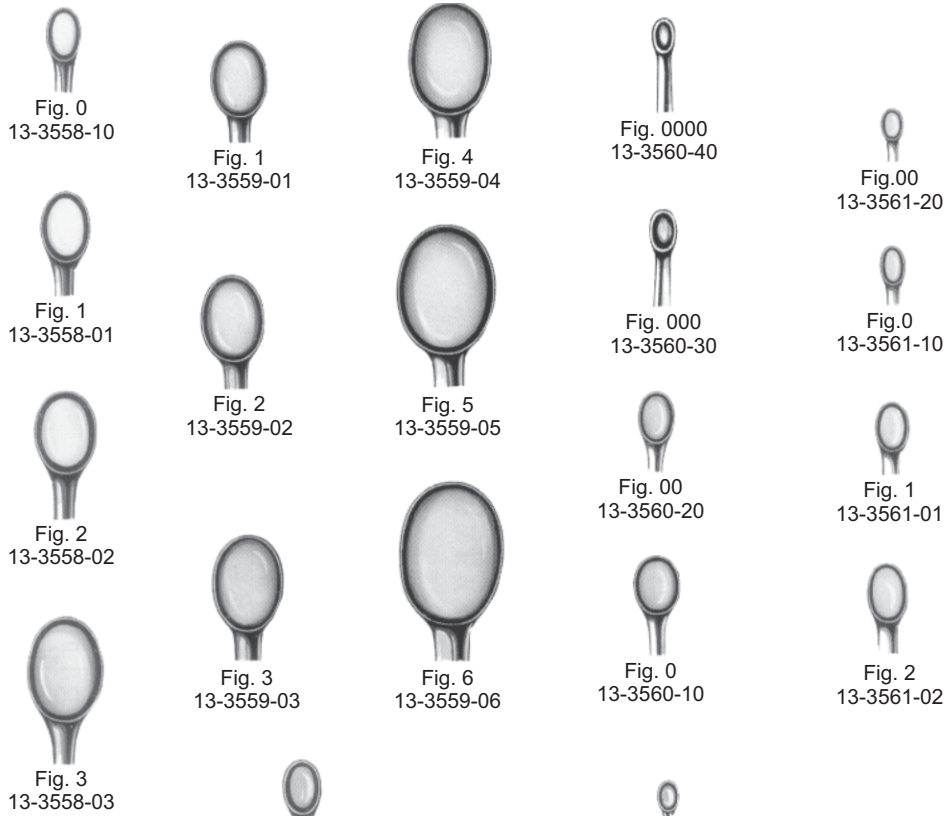

**Volkmann**  
27 cm/10½"



**Simon**  
24 cm/9½"



**Simon**  
24 cm/9½"



**Daubenspeck**  
20 cm/8"





**BONE SURGERY**  
 Bone Holding Forceps  
 Knochenhaltezangen  
 Pinzas para huesos



**Martin**  
 13-3562-19  
 19 cm/7½"



**Preston**  
 13-3563-18  
 18 cm/7¼"

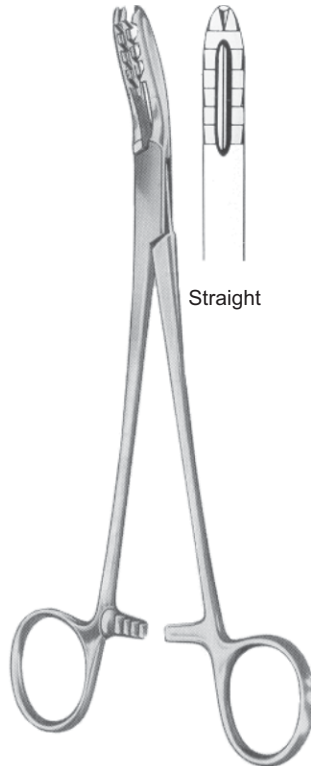

**Bircher-Ganske**  
 13-3564-20  
 20 cm/8"

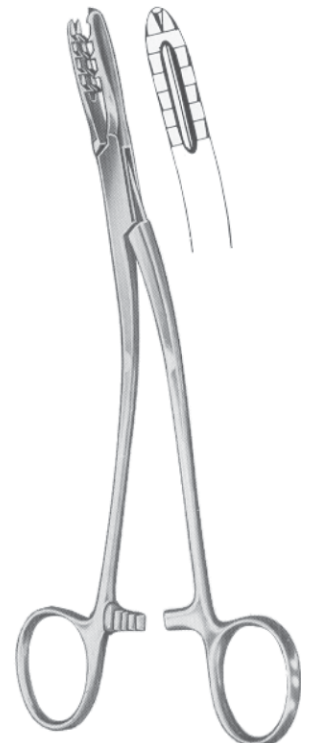

**Bircher-Ganske**  
 13-3565-20  
 20 cm/8"



**Lewin**  
 13-3566-17  
 17.5 cm/7"



**Langenbeck**  
 13-3567-21  
 21 cm/8¼"



**Fergusson**  
 13-3568-21  
 21 cm/8¼"

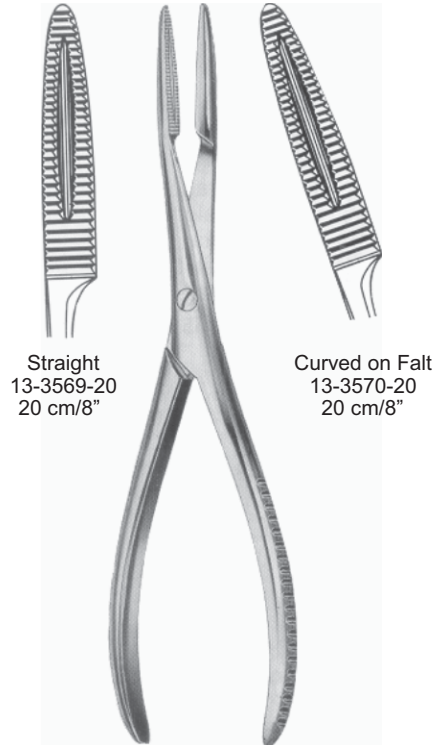

**Straight**  
 13-3569-20  
 20 cm/8"

**Curved on Falt**  
 13-3570-20  
 20 cm/8"



**Van Buren**  
 13-3571-23  
 23 cm/9"



**Dingmann**  
 13-3572-19  
 19cm/7½"



**Dingmann Modif**  
 13-3573-19  
 19 cm/7½"



**Neff**  
 13-3574-21  
 21 cm/8¼"



**Farabeuf-Lambotte**  
 13-3587-26  
 26 cm/10¼"



**Lambotte**  
 13-3588-19 19 cm/7½"  
 13-3588-23 23 cm/9"  
 13-3588-26 26 cm/10¼"



<b>Without Ratchet</b>	<b>Lane</b>	<b>With Ratchet</b>
	cm in	
13-3589-33	33 13"	13-3590-33
13-3589-45	45 17¾"	13-3590-45



13-3591-14  
 14.5 cm/5¾"



13-3592-12  
 12 cm/4¾"



13-3593-15 15 cm/6"  
 13-3593-19 19 cm/7 1/2"  
 13-3593-24 24 cm/9 1/2"  
 13-3593-26 26 cm/10 1/4"  
 13-3593-28 28 cm/11"

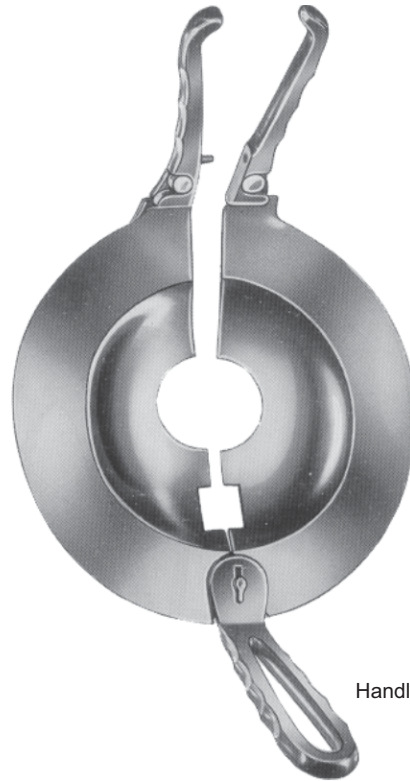

Handles Detachable

**Percy**  
 13-3594-30

Adjustable



**Lambotte**  
 13-3595-22 22 cm/8 3/4"  
 13-3595-27 27 cm/10 1/2"  
 13-3595-30 30 cm/12"



**Farabeuf**  
 13-3596-23 23 cm/9"  
 13-3596-26 26 cm/10 1/4"



**Lambotte**  
 13-3597-22 22.5 cm/9"  
 13-3597-25 25.5 cm/10 1/2"  
 13-3597-33 33 cm/13 1/2"



**BONE SURGERY**  
Bone Rongeur Forceps  
Hohlmeißelzangen  
Pinzas-gubias

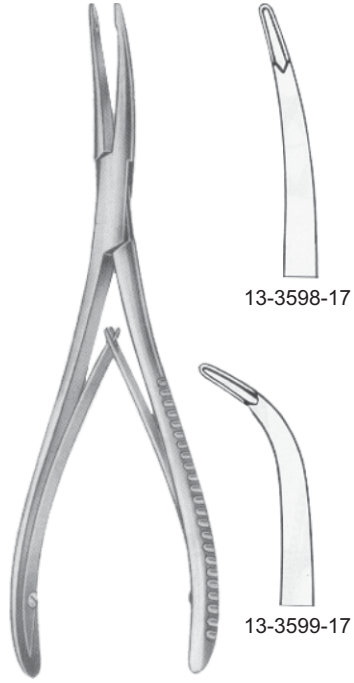

**Stellbrink**  
17.5 cm/7"



**Bane-Hartmann**  
13-3600-17  
17.5 cm/7"



**Mini-Friedmann**  
13-3601-12  
12.5 cm/5"



**Friedmann**  
13-3602-14  
14 cm/5½"



13-3603-13  
 13.5 cm/5 1/4"



13-3604-20  
 20 cm/8"



13-3605-17  
 17 cm/6 3/4"

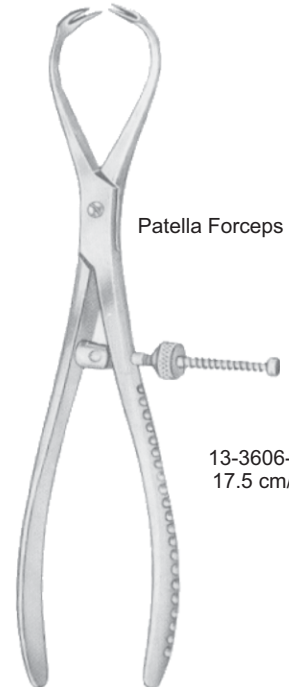

13-3606-17  
 17.5 cm/7"



**Lowman-Hoglund**  
 13-3607-19  
 19 cm/7 1/2"



**Lowman**  
 13-3608-18 18 cm/7"  
 13-3608-20 20 cm/8"  
 13-3608-22 22 cm/8 3/4"



**Lowman**  
 13-3609-12  
 12 cm/4 3/4"

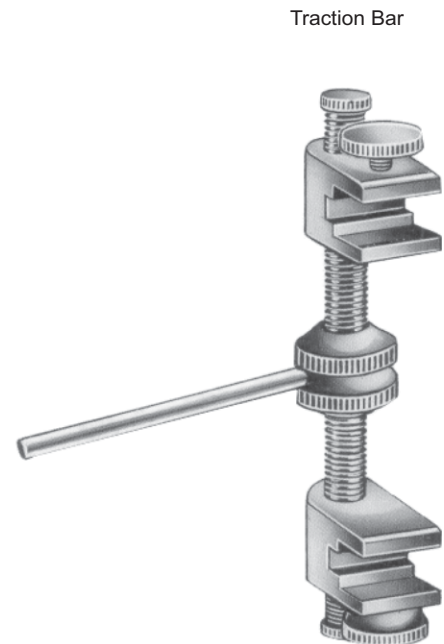

Traction Bar

13-3610-18  
 13-3610-50





**BONE SURGERY**  
 Bone Rongeur Forceps  
 Hohlmeißelzangen  
 Pinzas-gubias

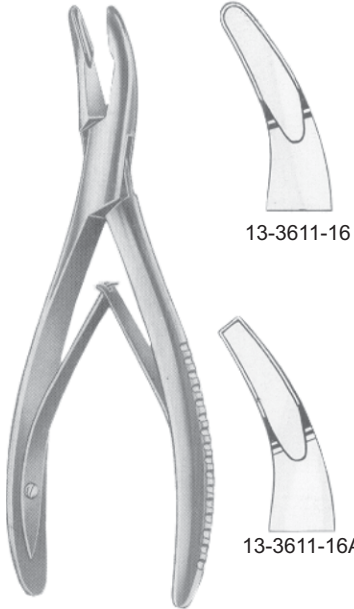

13-3611-16



13-3611-16A

**Mead**  
 16.5 cm/6½"



	<b>Lempert</b>	
	cm	in
Straight	16	6¼"
13-3612-16		
13-3612-19	19	7½"
	Curved	
	13-3613-16	
	13-3613-19	



**Beyer**  
 13-3614-18  
 18 cm/7"



**Jansen**  
 17.5 cm/7"



13-3615-17



13-3616-17



**Blumenthal**  
 15.5 cm/6"



13-3617-15



13-3618-15



13-3619-15



**Hakansson**  
 13-3620-15  
 15.5 cm/6"





**Friedmann-Delicate**  
 15 cm/6"

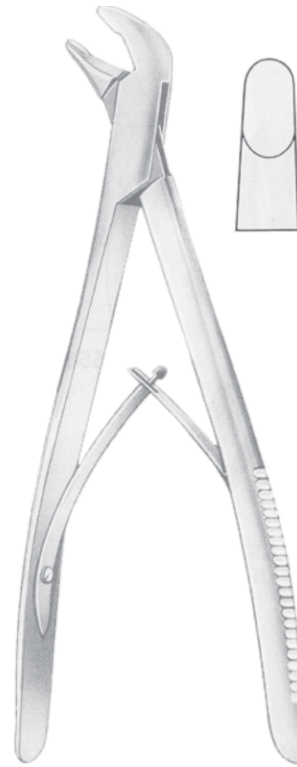

**Bacon**  
 13-3623-20  
 20 cm/8"



**Cleveland**  
 13-3624-14 14 cm/5½"  
 13-3624-17 17 cm/6¾"



**Hartmann**  
 13-3625-18  
 18.5 cm/7¼"

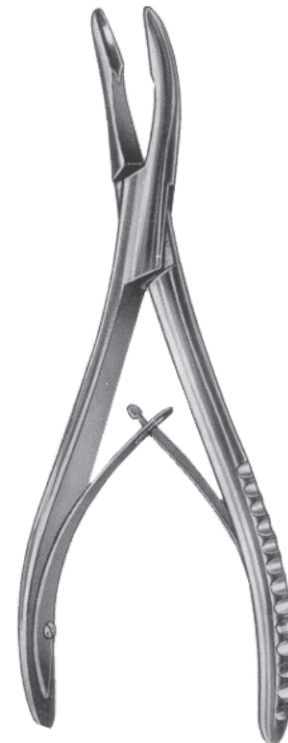

**Olivecrona**  
 13-3626-20  
 20 cm/8"



**BONE SURGERY**

Bone Rongeur Forceps  
Hohlmeißelzangen  
Pinzas-gubias



**Kleinert-Kutz**  
15 cm/6"



13-3627-15  
2 mm



13-3628-15  
3 mm



**Bohler**  
15 cm/6"



13-3629-15



13-3630-15



**Beyer  
Zaufal-Jansen**  
18 cm/7"



**Zaufal-Jansen**  
13-3631-18



**Beyer**  
13-3632-18



**Mayfield**  
13-3633-17  
17 cm/6¾"



**Ruskin**  
13-3634-18  
18 cm/7"  
Angled



**Straight**  
13-3635-18  
18 cm/7"  
13-3635-23  
23 cm/9"



**Ruskin**  
**Curved**  
13-3636-18  
18 cm/7"  
13-3636-23  
23 cm/9"



**Jansen**  
 13-3637-18  
 18 cm/7"



**Straight**  
 13-3638-17

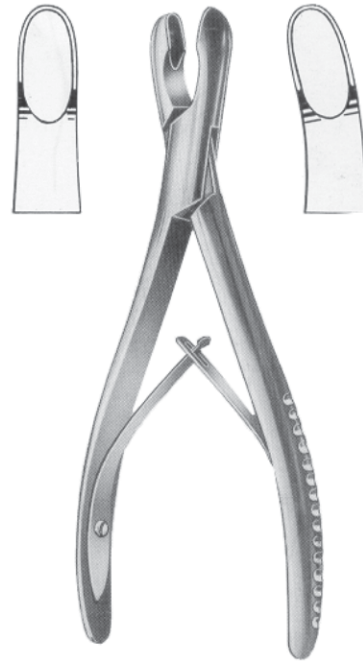

**Curved**  
 13-3639-17

**Luer**  
 17 cm/6¾"



**Heavy Pattern**

**Luer**  
 18.5 cm/7¼"

**Straight**  
 13-3640-18

**Curved**  
 13-3641-18



**Luer**  
 15 cm/6"



13-3642-15

13-3643-15

13-3644-15



**Adson**  
 20 cm/8"



13-3645-20



**BONE SURGERY**  
Bone Rongeur Forceps  
Hohlmeißelzangen  
Pinzas-gubias



**Stille-Luer**  
22 cm/8¾"



**Straight**  
13-3646-22



**Curved**  
13-3647-22



**Stille-Luer**  
27 cm/10½"



13-3648-27



13-3649-27



**Semb**  
13-3650-23  
23 cm/9"



13-3653-03  
3 mm



13-3653-04  
4 mm



13-3653-05  
5 mm



13-3653-03A  
3 mm



13-3653-04A  
4 mm



13-3653-05A  
5 mm



**Marquardt**  
13-3651-20  
20 cm/8"



**Rottgen-Ruskin**  
13-3652-24  
24 cm/9½"



**Smith-Petersen**  
24 cm/9½"



**BONE SURGERY**  
Wire Seizing Forceps  
Knochensplitterzangen  
Pinzas cortantes para huesos

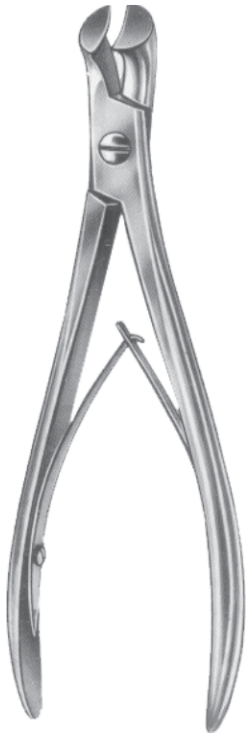

**Markwalder**  
13-3654-20  
20 cm/8"



**Straight**  
13-3655-14  
13-3655-17  
13-3655-19  
13-3655-22

cm  
14  
17  
19  
22



**Liston**  
13-3656-14  
13-3656-17  
13-3656-19  
13-3656-22

in  
5½  
6¾  
7½  
8¾

**Curved**  
13-3656-14  
13-3656-17  
13-3656-19  
13-3656-22



**Littauer-Liston**  
13-3657-15  
15 cm/6"



**Cleveland**  
13-3658-15 15 cm/6"  
13-3658-17 17 cm/6¾"



**Bohler**  
15 cm/6"



**Straight**  
13-3659-15



**Curved on flat**  
13-3660-15



**McIndoe**  
13-3661-17  
17.5 cm/7"





**Stille-Ruskin**  
 13-3662-23  
 23 cm/9"

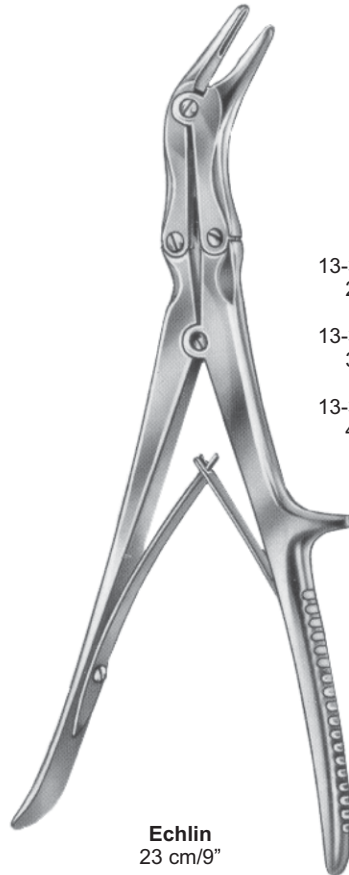

13-3663-02  
 2 mm  
 13-3663-03  
 3 mm  
 13-3663-04  
 4 mm

**Echlin**  
 23 cm/9"



**Leksell**  
 23 cm/9"

13-3664-03  
 3 mm  
 13-3664-04  
 4 mm  
 13-3664-06  
 6 mm  
 13-3664-08  
 8 mm



**Frykholm**  
 13-3665-23  
 23 cm/9"



**Stille**  
 13-3666-23  
 23 cm/9"

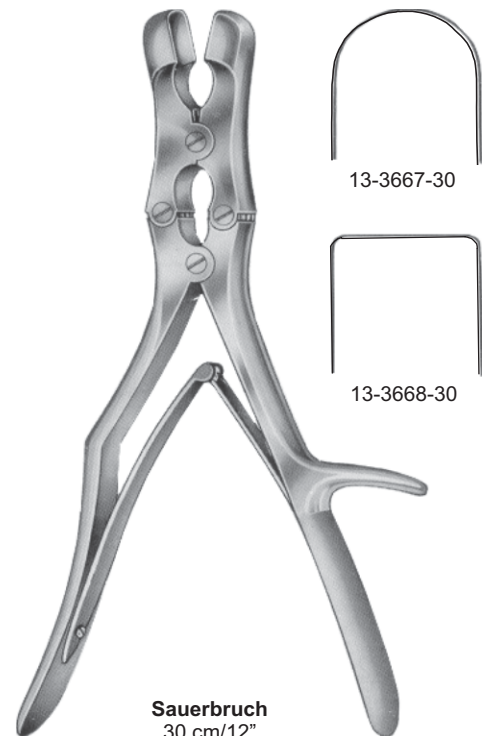

**Sauerbruch**  
 30 cm/12"

13-3667-30

13-3668-30





**BONE SURGERY**  
Bone Cutting Forceps  
Knochensplitterzangen  
Pinzas cortantes para huesos



13-3669-13  
13.5 cm/5"



18 cm/7"

Forceps for tearing out toe and finger nails

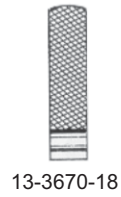

13-3670-18

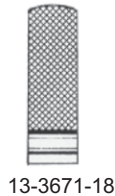

13-3671-18



13-3672-13  
13.5 cm/5¼"

Saw blade



13-3673-17  
17 cm/6¾"



13-3674-17  
17 cm/6¾"

Saw blade



**Kazanjan**  
 13-3675-18  
 18 cm/7"



**Ruskin-Liston**  
 18.5 cm/7¼"

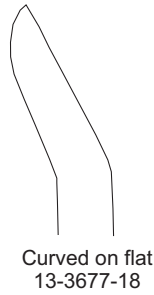

**Stille-Liston**  
 23 cm/9"  
 27 cm/10½"

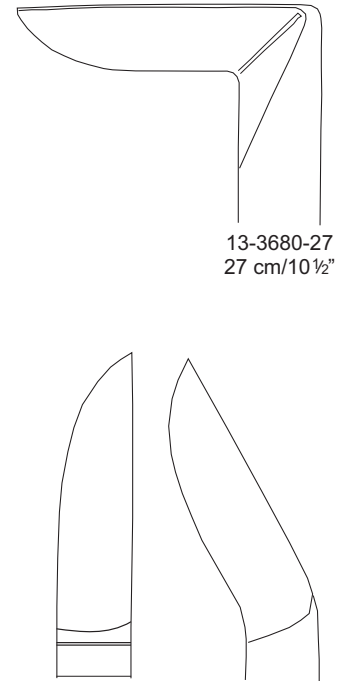

13-3678-23  
 13-3678-27

13-3679-23  
 13-3679-27



**Liston-Key(Horsley)**  
 13-3681-27  
 27 cm/10½"

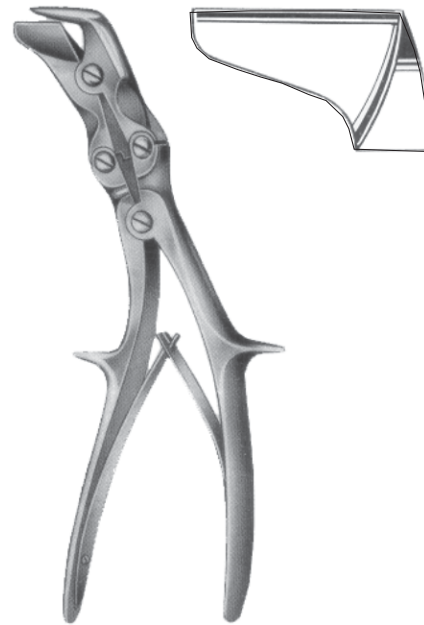

**Semb**  
 13-3682-24  
 24 cm/9½"



**BONE SURGERY**  
Wire Seizing Forceps  
Faßzangen  
Pinzas para coger



13-3683-13 13 cm/5"  
13-3683-18 18 cm/7"

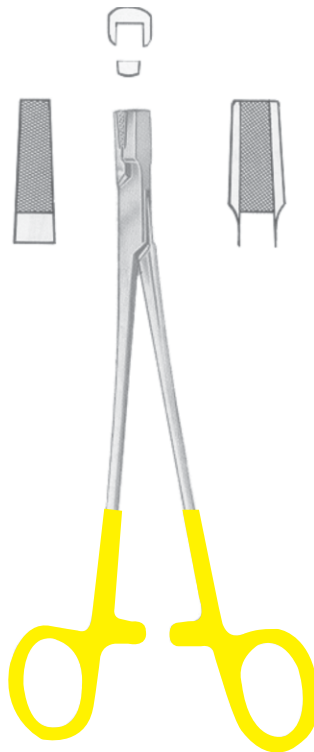

13-3684-17  
17 cm/6¾"

**TC**

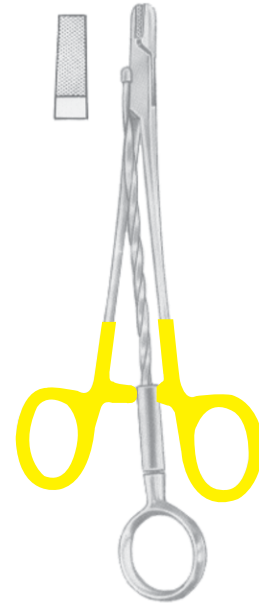

13-3685-15  
15.5 cm/6"



13-3686-17 17 cm/6¾" 13-3687-17

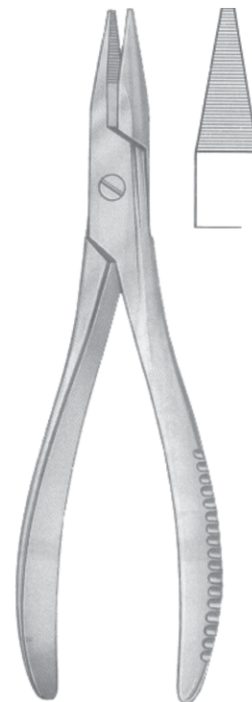

13-3688-19  
19 cm/7 ½"

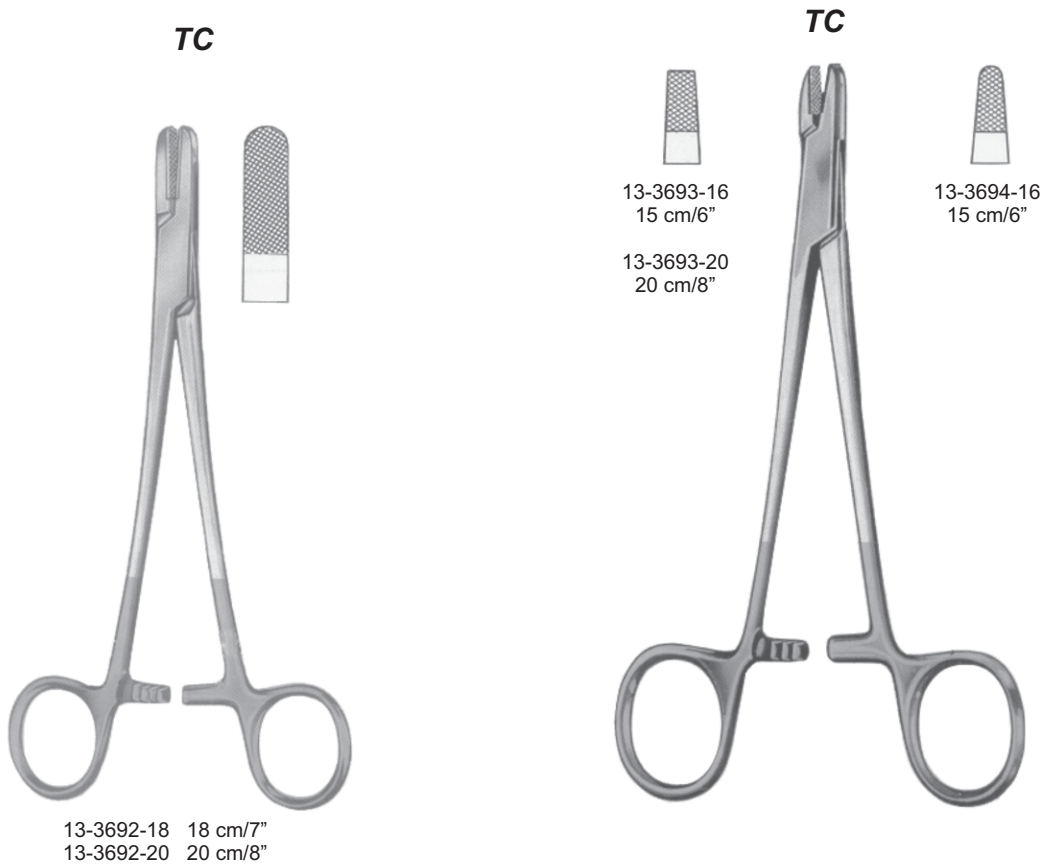
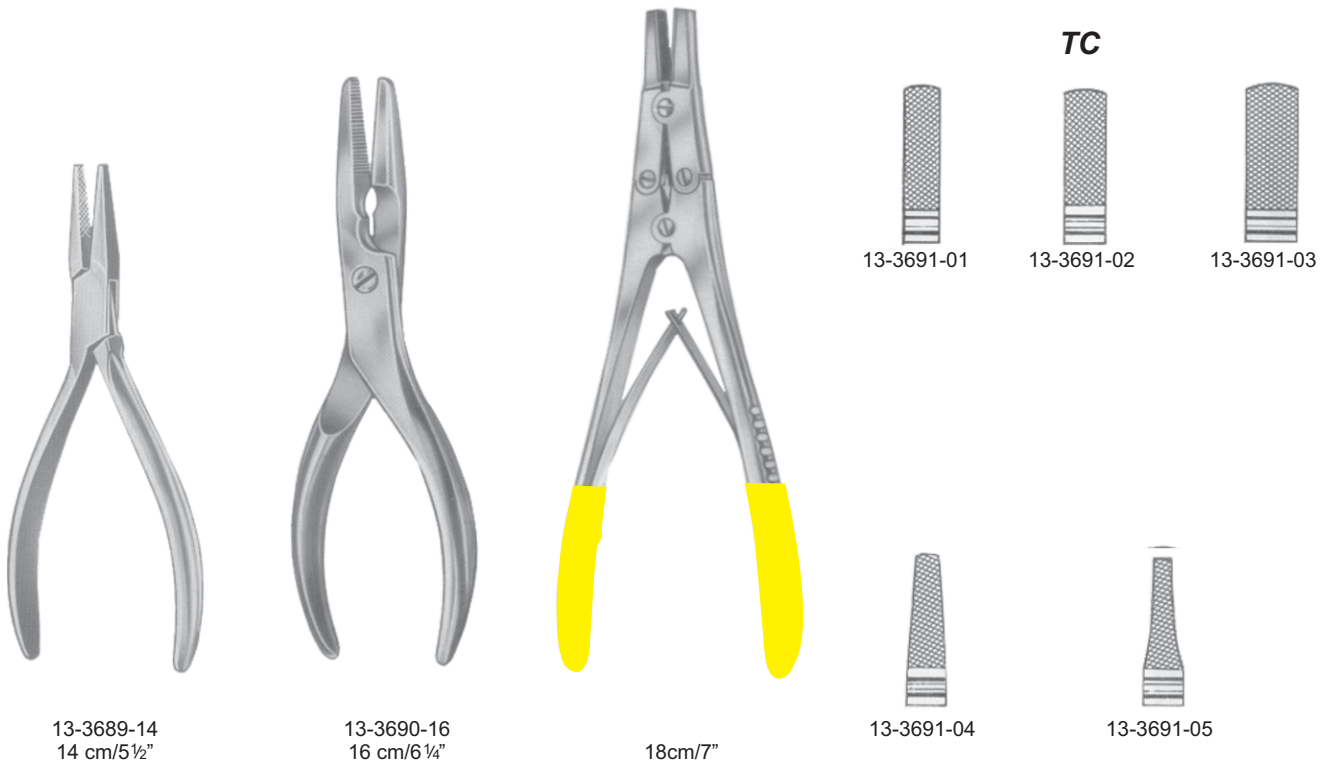



**BONE SURGERY**  
 Wire Cutting Pliers  
 Draht-Kneifzangen  
 Alicates para cortar alambre



For soft wire  
with a diam. of max.

13-3695-15  
15 cm/6"  
2.0 mm

13-3696-18  
18.5 cm/7¼"  
1.7 mm

13-3697-16  
16 cm/6¼"  
2.0 mm

For hard wire  
with a diam. of max.

1.5 mm

1.7 mm

2.0 mm



**TC**



13-3698-12  
0.7 mm  
0.5 mm  
12 cm/4¾"



13-3699-15  
2.0 mm  
1.0 mm  
15 cm/6"



13-3700-18  
2.0 mm  
1.7 mm  
18 cm/7"



213-3701-18  
2.5 mm  
1.5 mm  
18.5 cm/7¼"



13-3702-18  
2.0 mm  
1.7 mm  
18 cm/7"



13-3703-22  
3.0 mm  
2.5 mm  
22 cm/8¾"



13-3704-22  
3.0 mm  
22 cm/8¾"



Screw Nut Wrench



13-3705-10  
10 cm/4"

Screw Driver



13-3706-12  
12 cm/4 3/4"

Wire Strainer



13-3707-20  
20 cm/8"

Fixation Discs For Drill Wires



13-3708-30  
Pair



13-3709-40



13-3710-42

Fixation Discs



13-3711-51  
Pair





With 1 Pin

**Bohler**

cm	in	
h x b	h x b	For Arm
16 x 9	6¼ x 3½	13-3712-16

cm	in	
		For Thigh and Knee
21 x 11	8¼ x 4½	13-3713-21



With 3 Traction Hooks

**Kirschner**

Clear Width	cm	in
13-3714-01	9.5x7	3¾x2¾
13-3714-02	10.5x10.5	4¼x4¼
13-3714-03	12x12	4¾x4¾
13-3714-04	15.5x15.5	6x6
13-3714-05	20x15.5	8x6



Clear Width

	cm	in
13-3715-18	18x10	07x04
13-3715-27	27x16	10½x06¼



With 3 Traction Hooks

**Kirschner**

13-3716-01	Small Pattern
13-3716-02	Medium Pattern
13-3716-03	Large Pattern



7 mm Ø



Spare Screw

13-3717-34  
34cm/13½"

Tendon Passing Instruments



Malleable

**Bunnell**  
13-3718-18 18cm/7"  
13-3718-23 23cm/9"

Tendon Strippers



mm Ø  
4.0 13-3719-40  
4.5 13-3719-45  
5.5 13-3719-55  
Flexible Shaft

**Bunnell**  
23cm/9"



**Fischer**  
13-3720-31  
31 cm/12¼"



**Brand**



13-3721-50  
50 cm/19½"  
06 mm Ø



13-3722-30  
30 cm/12"  
03 mm Ø



6 x 14 mm

**Brand**  
13-3723-50  
50 cm/19½"



Bone Wire Guides



Bone Wire Tighteners

**Loute**  
 13-3724-00  
 21 cm/8¼"



Bone Wire Guides

Fig. 1 13-3725-01  
 Fig. 2 13-3725-02  
 Fig. 3 13-3725-03

**Demel**

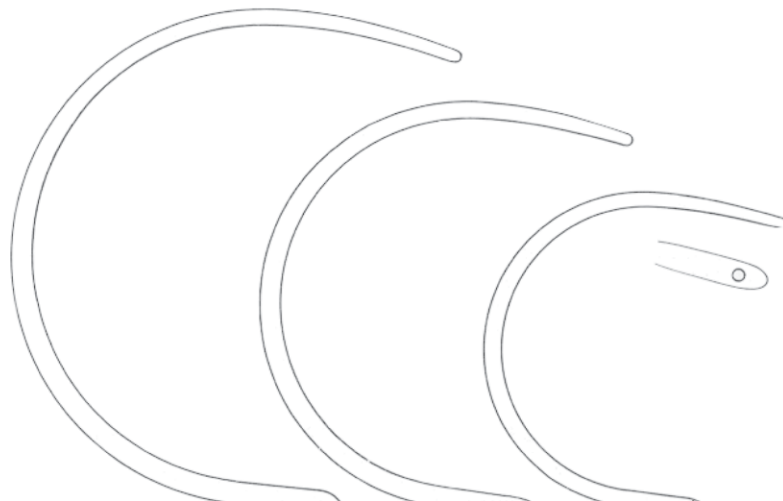
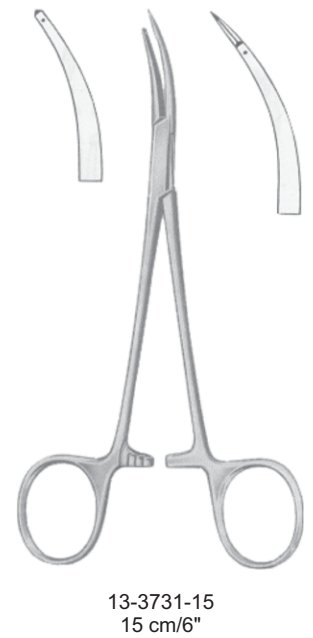
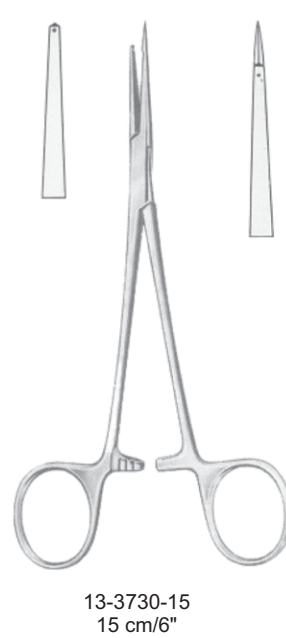
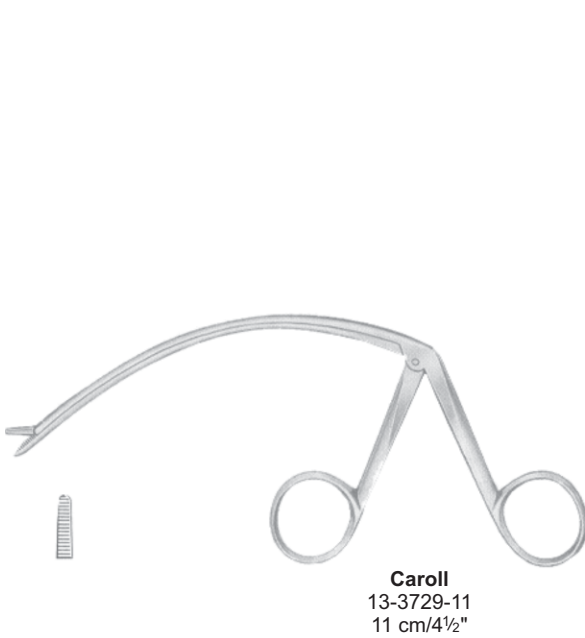
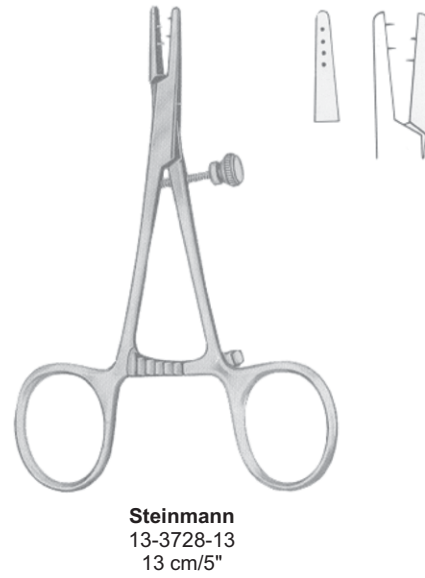
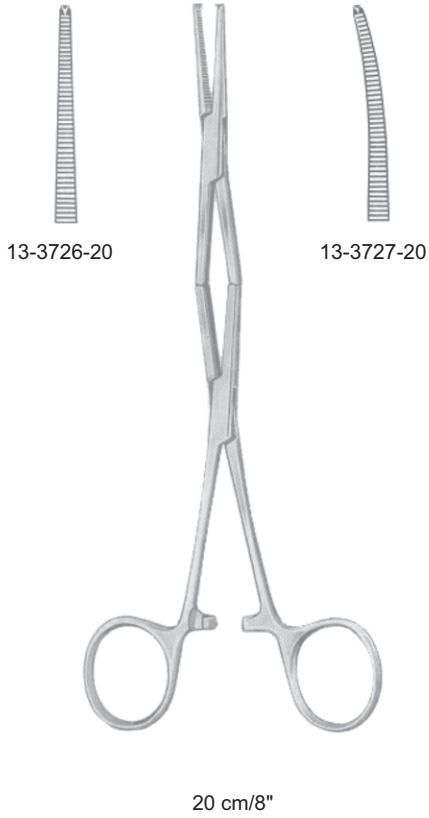

Fig. 1

Fig. 2

Fig. 3





**Steinmann**  
 13-3732-16  
 16 cm/6¼"



**Larsen**  
 10 cm/4"

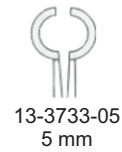
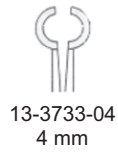
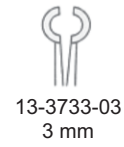

**Kleinert-Kutz**  
 13-3734-20  
 20 cm/8"



**Brand**  
 13-3735-15 15 cm/6"  
 13-3735-19 19 cm/7½"  
 13-3735-24 24 cm/9½"



**Brand**  
 13-3736-15 15 cm/6"  
 13-3736-19 19 cm/7½"  
 13-3736-24 24 cm/9½"