



Fraenkel
18-5001-01 Fig. 1
18-5001-02 Fig. 2
18-5001-03 Fig. 3



18-5002-01
18-5002-02
18-5002-03
13 cm/5"



Fig. 1
18-5003-01
18-5003-01



Fig. 2
18-5004-02
18-5004-02



Fig. 3
18-5005-03
18-5005-03



18-5006-01
18-5006-02
18-5006-03
13 cm/5"



Hartmann
15 cm/6"

18-5007-01

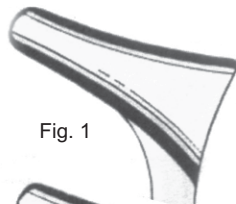

Fig. 1

18-5007-02

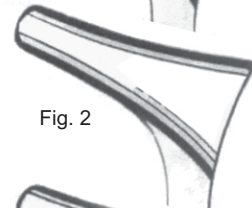

Fig. 2

18-5007-03

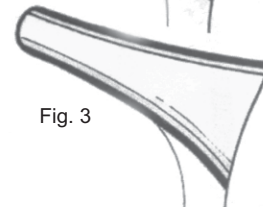

Fig. 3

18-5008-01



Hartmann
15 cm/6"

18-5008-02

18-5008-03



18-5009-01

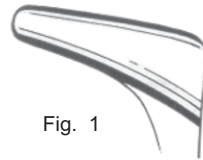

Fig. 1

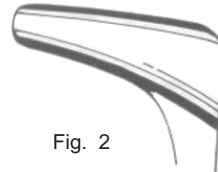

Fig. 2

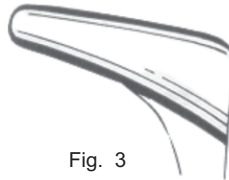

Fig. 3

18-5009-02

18-5009-03

Hartmann-Halle
15 cm/6"



18-5010-01

18-5010-02

18-5010-03

Hartmann-Halle
15 cm/6"



18-5011-01

18-5011-02

Tieck
13.5 cm/5 1/4"

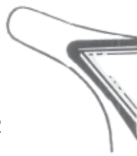

18-5012-01

18-5012-02



Tieck
13.5 cm/5 1/4"



Beckmann
15 cm/6"

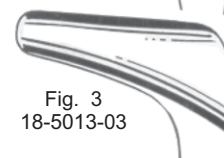
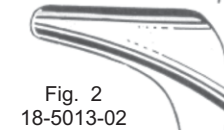

Fig. 1
18-5013-01

Fig. 2
18-5013-02

Fig. 3
18-5013-03



Mod.Wien

18-5014-01



Fig.1

18-5014-02

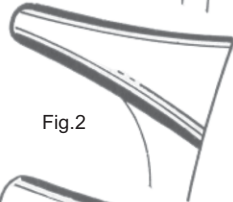

Fig.2

18-5014-03

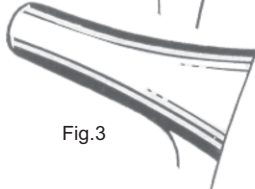

Fig.3

18-5015-01



Wien

18-5015-02

18-5015-03



Killian



Fig.1
18-5016-01
35 mm

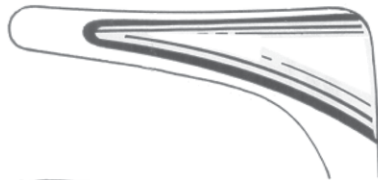

Fig.2
18-5016-02
50 mm

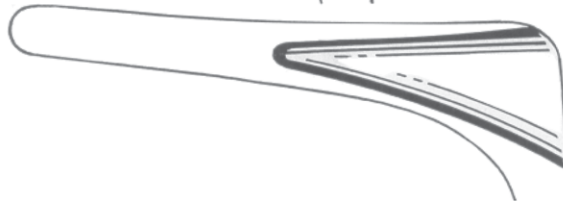

Fig.3
18-5016-03
75 mm

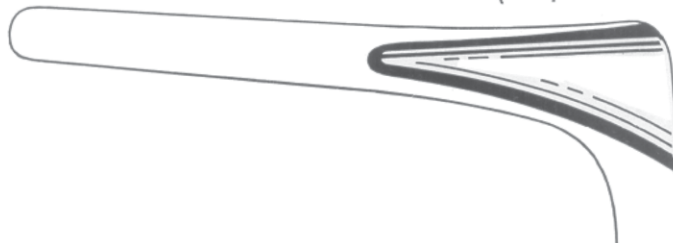

Fig.4
18-5016-04
90 mm



Cottle
 18-5017-01
 18-5017-02
 18-5017-03
 18-5017-04
 15 cm/6"

Cottle
 18-5018-01
 18-5018-02
 18-5018-03
 18-5018-04
 15 cm/6"

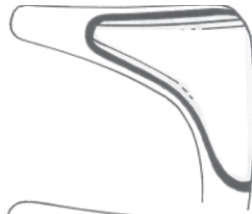

Fig 1
 18-5017-01
 18-5018-01
 35 mm

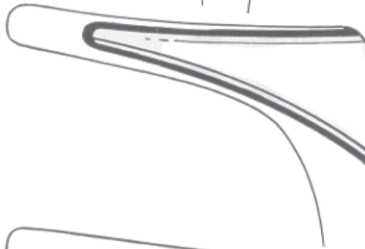

Fig 2
 18-5017-02
 18-5018-02
 50 mm

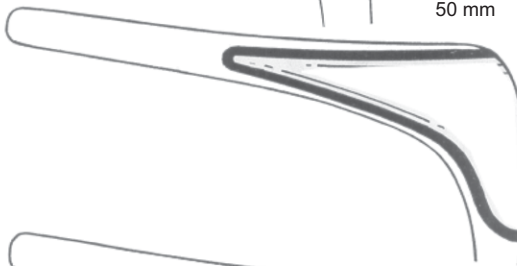

Fig 3
 18-5017-03
 18-5018-03
 75 mm

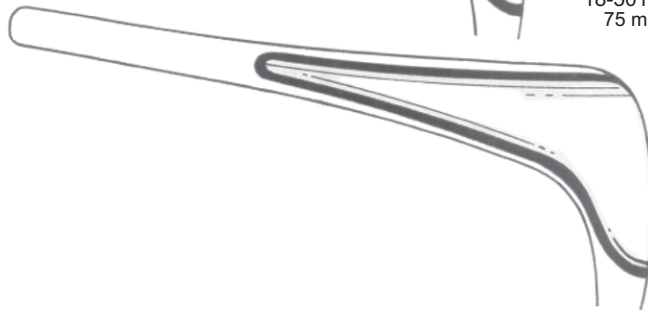
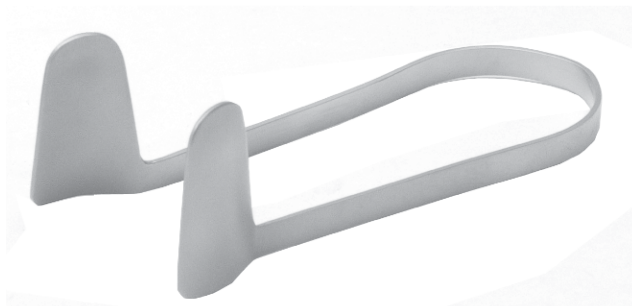

Fig 4
 18-5017-04
 18-5018-04
 90 mm



Thudicum Nasal Speculum
 Length 7 cm

- 18-5019-30 No. 1- 3 (set of 3)
- 18-5019-40 No. 1- 4 (set of 4)
- 18-5019-70 No. 1- 7 (set of 7)



18-5019-01 No. 1 18-5019-02 No. 2 18-5019-03 No. 3 18-5019-04 No. 4



18-5019-05 No. 5 18-5019-06 No. 6 18-5019-07 No. 7



RHINOLOGY

Nasal Snares, Dressing and Tampon Forceps
 Polypenschnürer, Tamponpinzetten und -zangen
 Polipótomos, Pinzas para compresas y tanopamientos

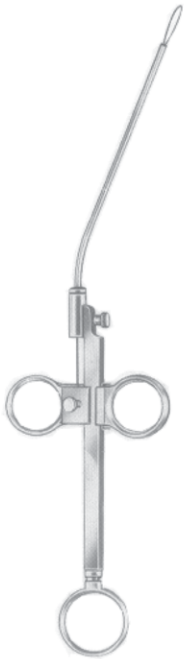

Krause
 18-5020-26
 26 cm/10 1/4"



Krause-Voss
 18-5021-26
 26 cm/10 1/4"



Lange-Wilde
 18-5022-24
 24 cm/9 1/2"



Package Of 1 Dozen Each
 18-5023-10
 0.3 mm



Cm	In
15.0	6
18.0	7
20.0	8



Cm	In
15.0	6
18.0	7
20.0	8



Westmacott (West)
 18-5026-20
 20 cm/8"



Lubet-Barbon
 18-5027-20
 20 cm/8"



Hartmann
 18-5028-16
 16 cm/6 1/4"



Hartmann
 18-5029-20
 20 cm/8"



Heymann
 18-5030-18
 18 cm/7"



Craig
 18-5031-18
 18 cm/7"



18-5032-01

18-5032-02

Craig Domnick
 18 cm/7"

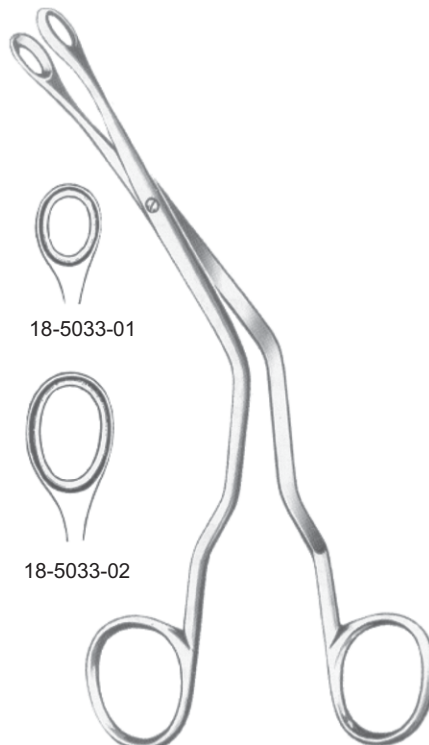

18-5033-01

18-5033-02

Luc
 20 cm/8"

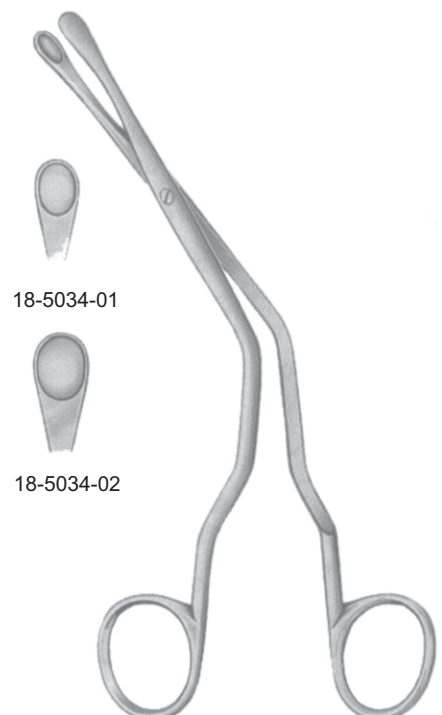

18-5034-01

18-5034-02

Luc
 20 cm/8"



RHINOLOGY

Septum Compression Forceps
Septumzange
Pinza para el tabique nasal



- 18-5035-01
- 18-5035-02
- 18-5035-03
- 18-5035-04



Bruenings
19 cm/7½"

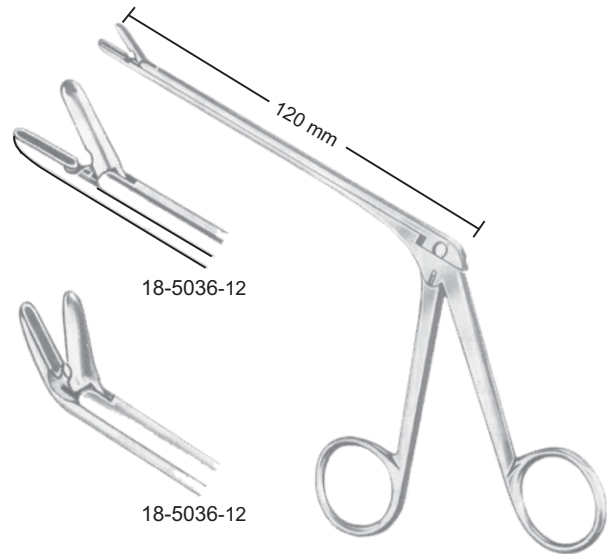

Takahashi
19 cm/7½"

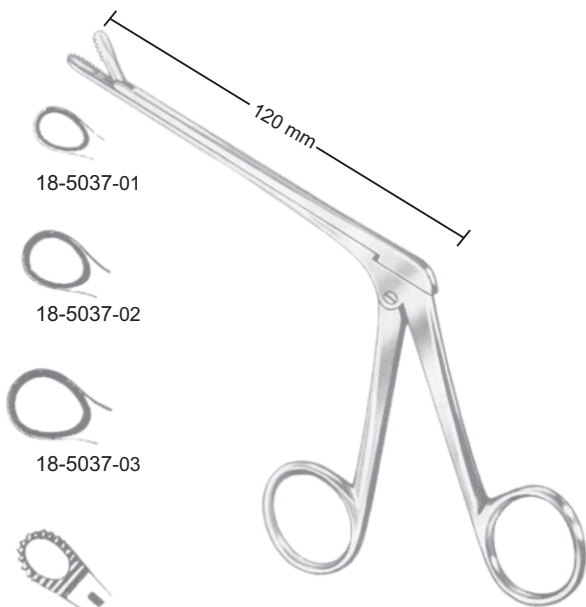

Watson-Williams
19 cm/7½"

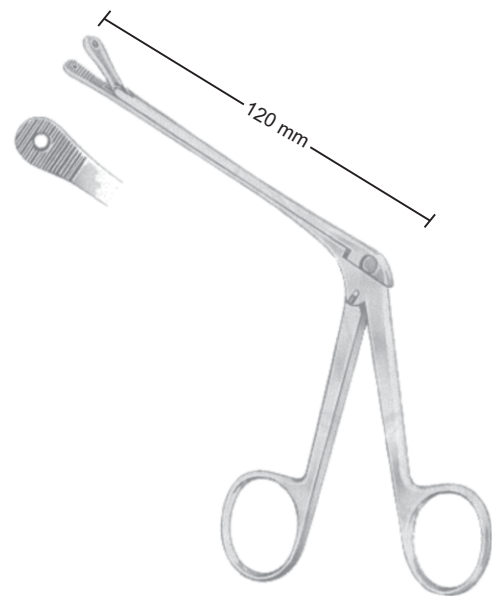

Ferris-Smith
18-5038-12
19 cm/7½"

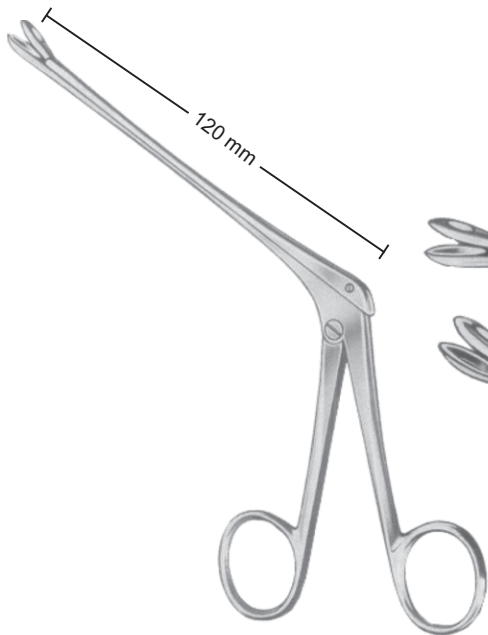

Weil-Blakesley

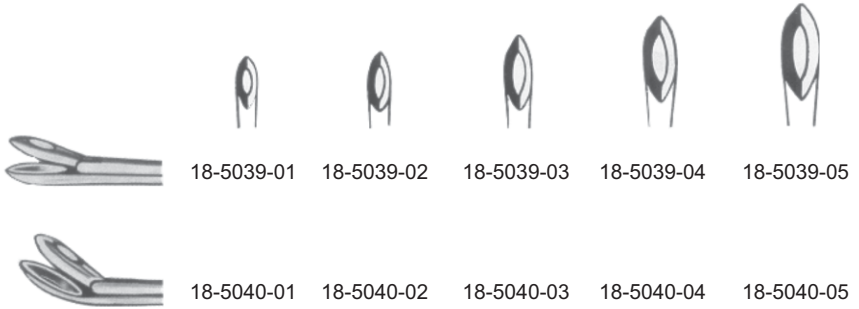

Struycken

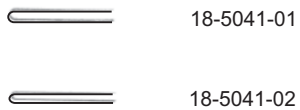

Hajek

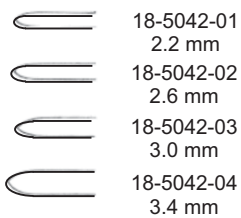

Myles

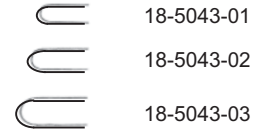

Grunwald

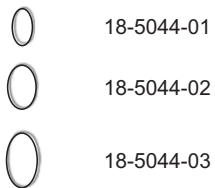

Hartmann

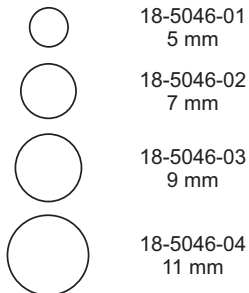

Schmeden

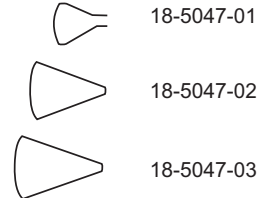

Grunwald
18-5045-01





RHINOLOGY

Septum Compression Forceps
 Septumzange
 Pinza para el tabique nasal

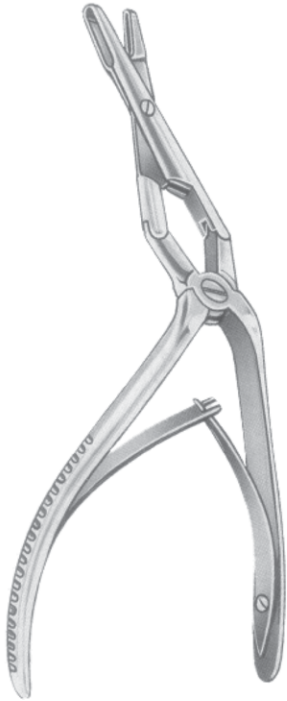

Middleton-Jansen
 18-5048-19
 19 cm/7½"

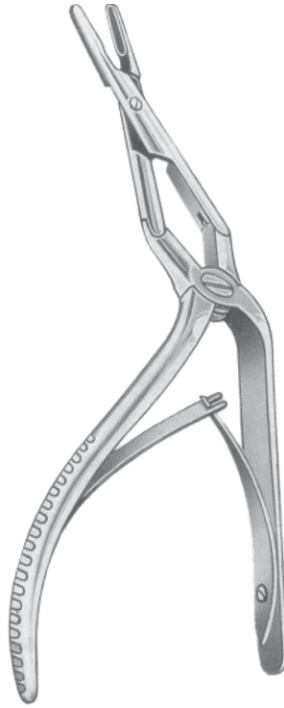





Middleton-Jansen
 18-5049-19
 19 cm/7½"



Kazanjian
 18-5050-18
 18 cm/7"



Caplan
 18-5051-20
 20 cm/8"

-  18-5052-01
5x4 mm
-  18-5052-02
5x4 mm
-  18-5052-03
5x3.5 mm
-  18-5052-04
5x3.5 mm

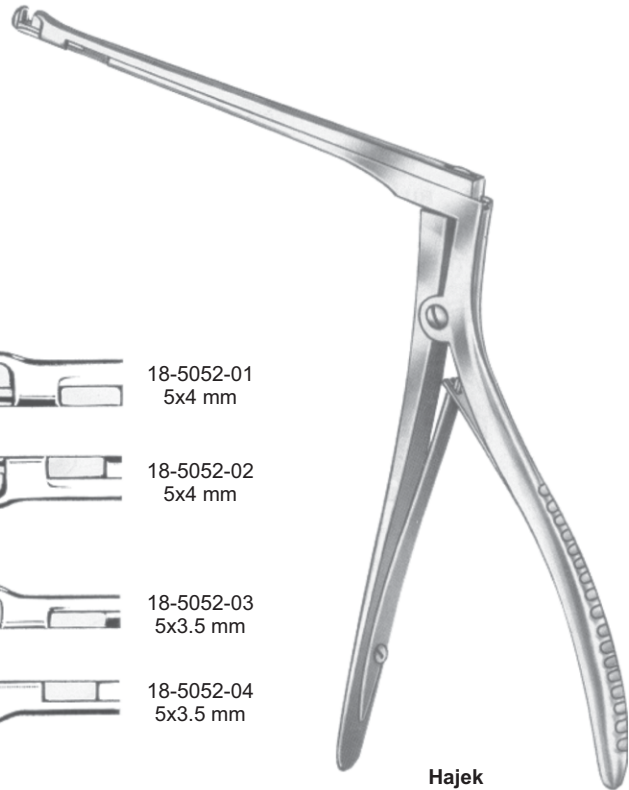

**Hajek
 (Hajek-Kofler)**
 Shaft
 14 cm/5½"



Ferris-Smith-Kerrison



Ferris-Smith-Kerrison

		Width of Bite		Length of Shaft		Width of Bite		Length of Shaft	
		15 cm/6"	20 cm/8"	18 cm/7"	15 cm/6"	20 cm/8"	18 cm/7"		
Cutting Upward		18-5053-03 3 mm	18-5056-03	18-5059-03	18-5061-03	18-5064-03	18-5067-01		
		18-5053-05 5 mm	18-5056-05	18-5059-05	18-5061-05	18-5064-05	18-5067-02		
Cutting Upward 40°		18-5054-03 3 mm	18-5057-03		18-5062-03	18-5065-03	18-5068-01		
		18-5054-05 5 mm	18-5057-05		18-5062-05	18-5065-05	18-5068-02		
Cutting Downward		18-5055-03 3 mm	18-5058-03	18-5060-03	18-5063-03	18-5066-03	18-5069-01		
		18-5055-05 5 mm	18-5058-05	18-5060-05	18-5063-05	18-5066-05	18-5069-02		



360° Turnable

Hajek-Kofler
18-5070-16
16 cm/6½"

- 18-5071-03
3 mm
- 18-5071-04
4 mm
- 18-5071-05
5 mm
- 18-5071-06
6 mm



Kerrison
20 cm/8"



RHINOLOGY

Adenoid Cutting Forceps and Nasal Knives
Adenoid Cutting Pinzetten und Nasal Messer
Adenoides pinzas de cortar y cuchillos nasal



Jurasz
22 cm/8¾"



18-5072-01



18-5072-02



18-5072-03

Rhinoplastic and Nasal Knives



Joseph
Pointed

← Straight
18-5073-01



Curved
18-5074-01



Joseph
Blunt

← Straight
18-5075-01



Curved
18-5076-01



Converse
18-5077-15
15 cm/6"



Joseph
18-5078-14
14 cm/5½"



Cottle
 18-5079-15
 15 cm/6"



Cottle
 18-5080-14
 14 cm/5½"



Freer
 18-5081-16
 16 cm/6¼"



Joseph
 18-5082-16
 16.5 cm/6½"



Maltz
 18-5083-16
 16.5 cm/6½"



Freer
 18-5084-19
 19 cm/7½"

Septum Knives



Ballenger
 20cm/8"



18-5085-03 3 mm 18-5086-03
 18-5085-04 4 mm 18-5086-04
 18-5085-05 5 mm 18-5086-05



Ballenger
 20cm/8"



Bruenings
 18-5087-16



RHINOLOGY

Nasal Septum Elevators
Septum-Elevatorien
Elevadores y Espátulas para el tabique nasal



18-5088-04 4 mm
18-5088-05 5 mm

Mc Kenty
15 cm/6"



Halle
18-5089-16
16.5 cm/6½"



Joseph
18-5090-16
16.5 cm/6½"



Cottle
18-5091-19
19.5 cm/7½"



Blunt

Freer
18-5092-19
19 cm/7½"



Sharp

Freer
18-5093-19
19 cm/7½"



Freer
18-5094-18
18 cm/7"



Freer-Yasargil
18-5095-18
18.5 cm/7¼"



Howarth
18-5096-21
21.5 cm/8½"



Mc Kenty
18-5097-22
22 cm/8¾"



Killian
 18-5098-18
 18.5 cm/7¼"



Cottle
 18-5099-23
 23 cm/9"



Killian
 18-5100-18
 18.5 cm/7¼"



Pierce
 18-5101-21
 21 cm/8¼"



Pennington
 18-5102-21
 21 cm/8¼"

Raspatories



18-5103-18
 18 cm/7"



**Joseph (Cottle)
 Masing**
 18-5104-22
 22 cm/8¾"



Masing
 18-5105-20
 20.5 cm/8⅜"



Joseph
 18-5106-16
 16cm/6¼"

Periost-Elevators



RHINOLOGY

Nasal Chisels and Gouges
 Nasal Meißel und Gouges
 Cinceles y gubias nasal



4 mm

Freer
 18-5107-16
 16 cm/6¼"



4 mm

Freer
 18-5108-16
 16 cm/6¼"



6 mm

Freer
 18-5109-15
 15 cm/6"



Ballenger
 18-5110-04 4 mm
 18-5110-06 6 mm
 18-5110-08 8 mm
 16 cm/6¼"



Killian
 18-5111-16
 16 cm/6¼"



Killian-Claus
 18-5112-16
 16 cm/6¼"

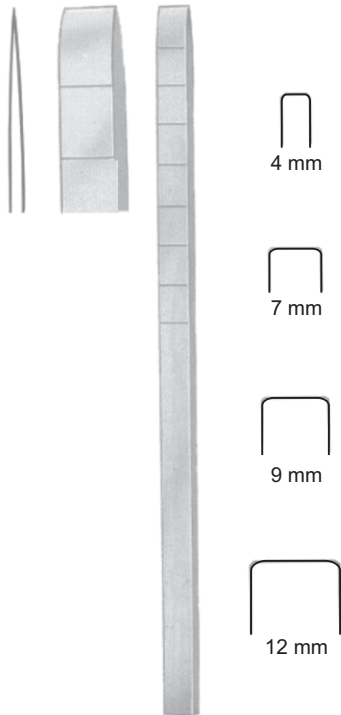

Cottle
 18-5113-04 4 mm
 18-5113-07 7 mm
 18-5113-09 9 mm
 18-5113-12 12 mm
 18 cm/7"



Cottle
 18-5114-04 4 mm
 18-5114-07 7 mm
 18-5114-09 9 mm
 18-5114-12 12 mm
 18 cm/7"



Cottle
 18-5115-18
 18 cm/7"



16 mm



Cottle
 18-5116-18
 18 cm/7"



18-5117-08
 16 cm/6¼"
 8 mm



Cottle
 18-5118-04 4 mm
 18-5118-07 7 mm
 18-5118-09 9 mm
 18-5118-12 12 mm
 18 cm/7"



Cottle
 Curved
 18-5119-06
 18 cm/7"
 6 mm



Fomon
 18-5120-05 5mm
 18-5120-08 8mm
 17 cm/6¾"



Walter
 18-5121-03 3 mm
 18-5121-04 4 mm
 18 cm/7"



18-5122-01



(Silver)
Masing
 18-5123-02
 17.5 cm/7⅞"



18-5124-03

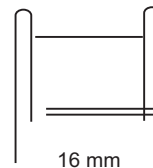
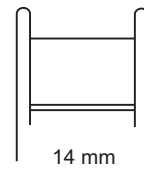
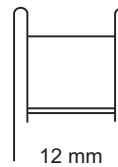
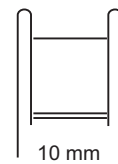

Cinelli
 18-5125-10 10 mm
 18-5125-12 12 mm
 18-5125-14 14 mm
 18-5125-16 16 mm
 16 cm/6¼"



Masing
 18-5126-17
 17.5 cm/6⅞"



RHINOLOGY

Nasal Septum Chisels and Nasal Saws
Nasenscheidewand Meißel und Sägen Nasal
Formones Sierras del tabique nasal y nasal



West
18-5127-16
16 cm/6¼"



West
18-5128-16
16 cm/6¼"

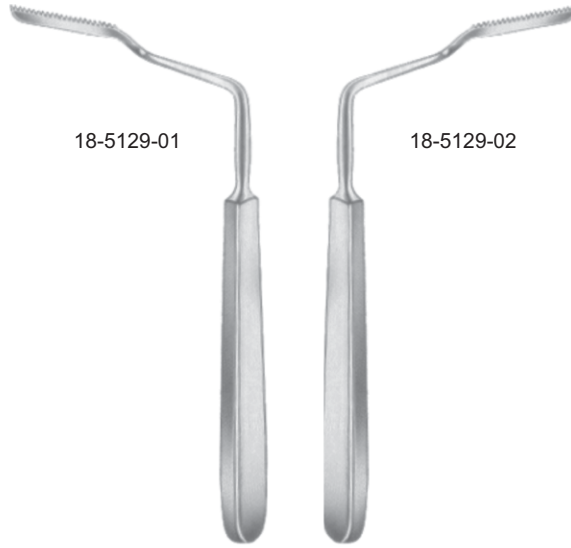

18-5129-01

18-5129-02

Joseph
17 cm/6¾"



Joseph
18-5130-01
17 cm/6¾"



Joseph
18-5131-02
17 cm/6¾"



Joseph
18-5132-03
17 cm/6¾"



TC

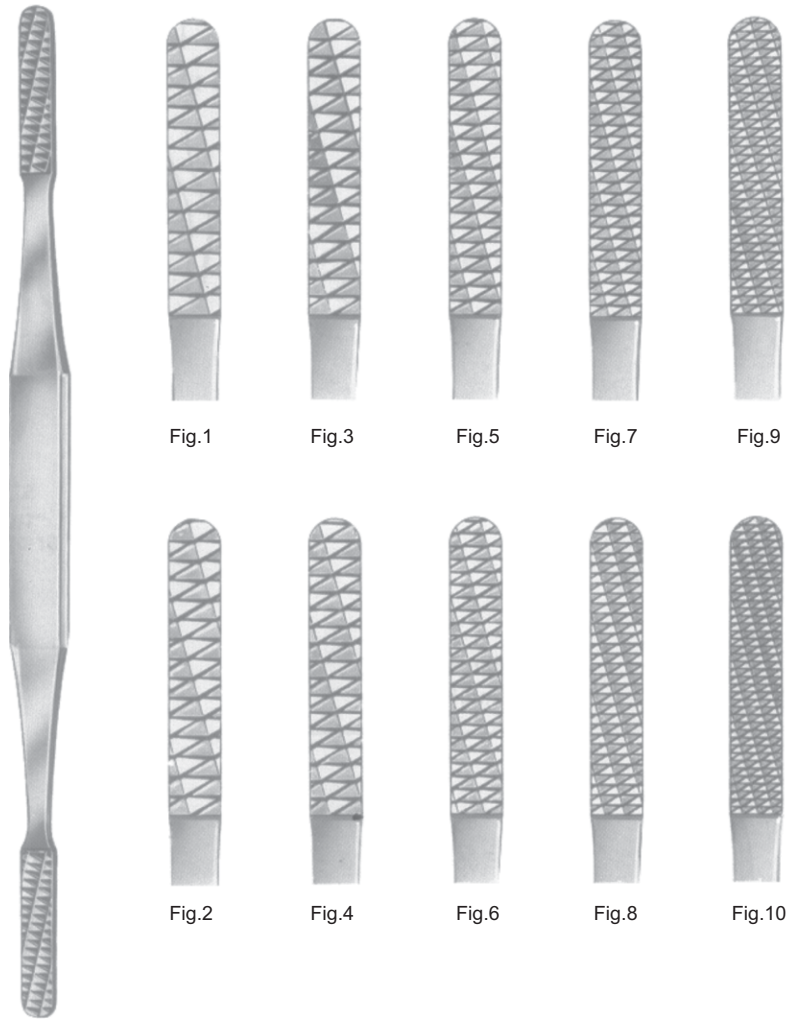

Fig.1
 Fig.2
 Fig.3
 Fig.4
 Fig.5
 Fig.6
 Fig.7
 Fig.8
 Fig.9
 Fig.10

Famon

- Fig. 1/ 2 18-5133-12
- Fig. 3/ 4 18-5133-34
- Fig. 5/ 6 18-5133-56
- Fig. 7/ 8 18-5133-78
- Fig. 9/10 18-5133-90
 21 cm/8 1/4"

TC



Parkes

- Fig. 1 18-5134-01
- Fig. 2 18-5134-02
- Fig. 3 18-5134-03
- Fig. 4 18-5134-04
- Fig. 5 18-5134-05
- Fig. 6 18-5134-06
- Fig. 7 18-5134-07
- Fig. 8 18-5134-08
- Fig. 9 18-5134-09
- Fig.10 18-5134-10
 20.5 cm/8 1/8"

Maltz

- Fig. 1 18-5135-01
- Fig. 2 18-5135-02
- Fig. 3 18-5135-03
- Fig. 4 18-5135-04
- Fig. 5 18-5135-05
- Fig. 6 18-5135-06
- Fig. 7 18-5135-07
- Fig. 8 18-5135-08
- Fig. 9 18-5135-09
- Fig.10 18-5135-10
 17 cm/6 3/4"



RHINOLOGY
Nasal Rasps
nasal Raspeln
Escofinas nasal



Maltz
18-5141-18
18 cm/7"



Joseph
16 cm/6¼"

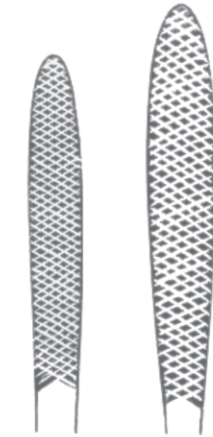

18-5142-01 18-5142-02



Lewis
18 cm/7"



Fine
18-5143-01



Coarse
18-5143-02



Cottle
18-5144-21
21 cm/8¼"



18-5145-01

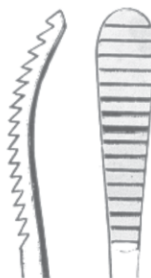

18-5145-02



Aufricht
21 cm/8¼"



Maltz
 17 cm/6¾"



Miller
 16 cm/6¼"

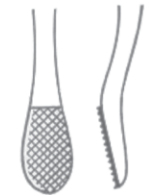
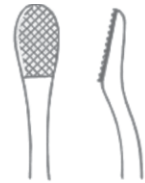

19 cm/7½"



Aufricht
 18-5139-17
 17.5 cm/6¾"

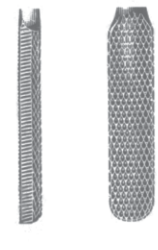
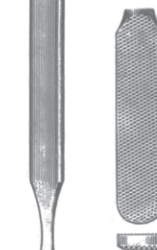
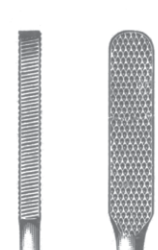

Fomon
 18-5140-21
 21 cm/8¼"



Hooks



Fomon
18-5146-14
14.5 cm/5 3/4"



Cottle
18-5147-14
14.5 cm/5 3/4"



Cottle
18-5148-14
14.5 cm/5 3/4"



Cottle
18-5149-14
14.5 cm/5 3/4"



Cottle
18-5150-16
15 cm/6"



Kilner
18-5151-08
8 cm/3 1/8"
10 mm

Columella Forceps

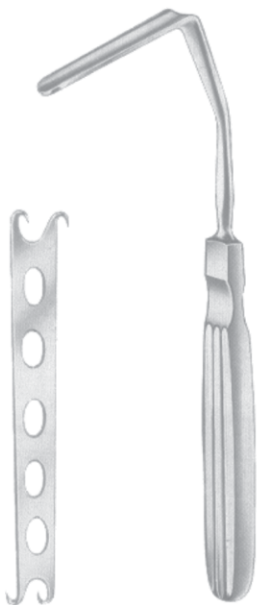

Converse
18-5152-12
12 cm/4 3/4"

Aufricht
18-5153-16
16 cm/6 1/4"



Cottle
18-5154-10
10 cm/4"

Tissue Lifter



18-5155-14
14 cm/5 1/2"

Tissue Picks



18-5156-11
11 cm/4 3/8"



1.0 mm 18-5157-10
1.8 mm 18-515718



Walsham
23 cm/9"



18-5158-01



18-5158-02



18-5158-03



Cottle-Walsham
18-5159-22
22 cm/8¾"



Asch
18-5160-23
23 cm/9"



Kressner
18-5161-20
20 cm/8"



Rubin
18-5162-20
20 cm/8"



RHINOLOGY

Nasal and Adenoid Curettes
 Nasal und Adenoid Küretten
 Nasal y adenoides Curetas



Faulkner
 18-5163-21
 21 cm/8¼"



Sewall
 18-5164-20
 20 cm/8"
 6 mm



Coakley
 17 cm/6¾"



18-5165-01



18-5165-02



18-5165-03



18-5165-04



18-5165-05



18-5165-06

Ringmesser

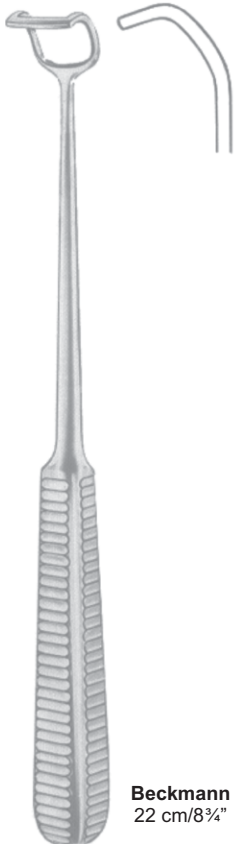

Beckmann
 22 cm/8¾"

18-5166-01



18-5167-01

18-5166-02



18-5167-02

18-5166-03



18-5167-03

18-5166-04



18-5167-04

18-5166-05



18-5167-05

18-5166-06



18-5167-06

Adenoid Curettes



Negus
 20 cm/8"

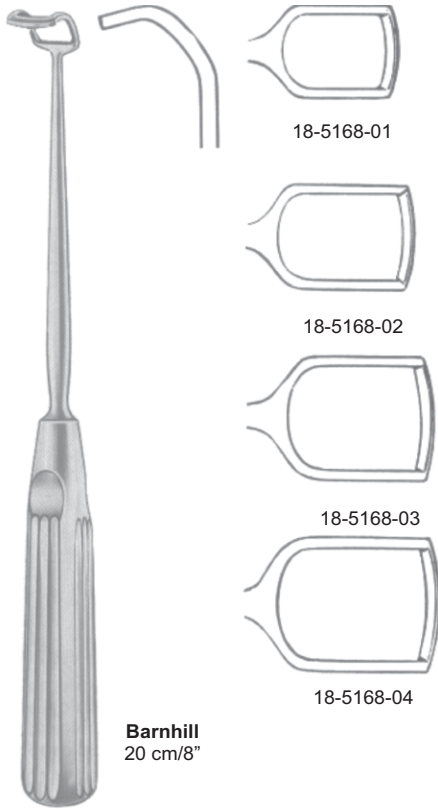

Barnhill
20 cm/8"

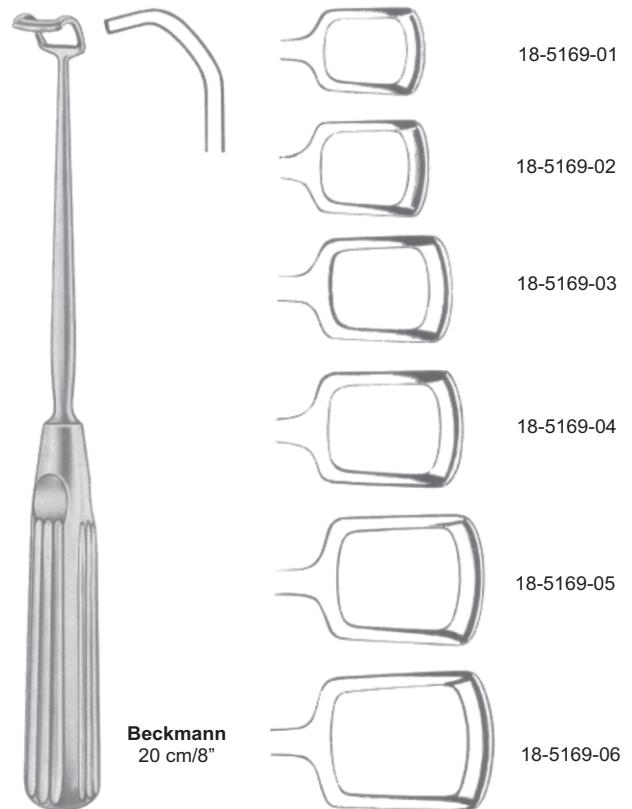

Beckmann
20 cm/8"

- 18-5170-10 10mm
- 18-5170-12 12mm
- 18-5170-14 14mm
- 18-5170-16 16mm
- 18-5170-18 18mm

- 18-5170-10A 10mm
- 18-5170-12A 12mm
- 18-5170-14A 14mm
- 18-5170-16A 16mm
- 18-5170-18A 18mm

St. Clair-Thompson
with graded
21.5cm/8 1/2"

St. Clair-Thompson
without graded
21.5cm/8 1/2"



18-5171-01

18-5171-02

18-5171-03

Spare blades Only

18-5171-11

18-5171-12

18-5171-13

La Force
23 cm/9"



RHINOLOGY

Antrum Retractor and Antrum Frontal Sinus Wash Cannulas
 Nasal und Adenoid CuAntrum Retractor und Antrum Frontal Sinus Wash Kanülen
 Nasal y adenoides CuAntrum Retractor y el antro del seno frontal lavado cánulas



Bruenings- Brunk
 18-5172-19
 91 cm/7½"

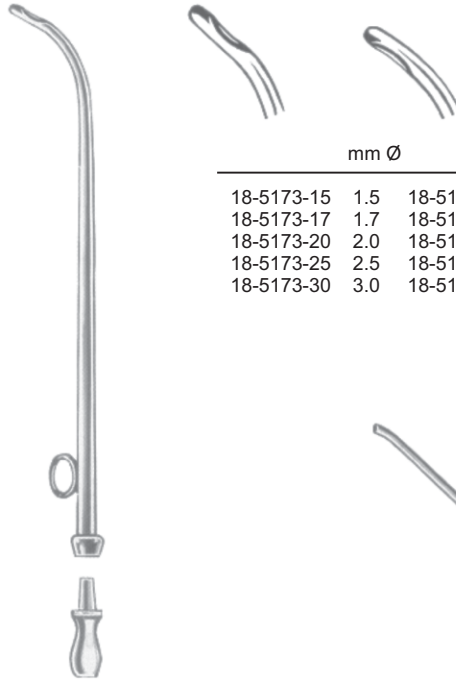

Siebenmann

mm Ø		
18-5173-15	1.5	18-5174-15
18-5173-17	1.7	18-5174-17
18-5173-20	2.0	18-5174-20
18-5173-25	2.5	18-5174-25
18-5173-30	3.0	18-5174-30



Fig. 1	mm Ø	Fig. 2
18-5175-20		18-5176-20
18-5175-25		18-5176-25
18-5175-30		18-5176-30



Eicken - Killian
 18-5177-03
 3 mm Ø



Killian
 18-5178-15
 1.5 mm Ø



Ritter - Halle
 2.5 mm 18-5179-25
 3.0 mm 18-5179-30
 4.0 mm 18-5179-40