



19

EN Ophthalmology

DE Ophthalmologie

ES Oftalmología

Page 435 to 465



Weiss
Children 19-5501-07
7 cm/2¾"
Adults 19-5502-09
9 cm/3½"



Weiss
Children 19-5503-07
7 cm/2¾"
Adults 19-5504-09
9 cm/3½"

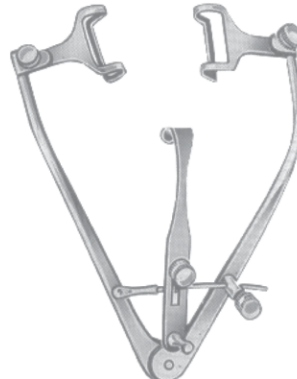

Park
19-5505-08
8 cm/3¼"



Park-Guyton
19-5506-08
8 cm/3¼"



Park-Maumenee
19-5507-08
8 cm/3¼"



Barraquer (Colibri)
Children 19-5508-03
3 cm/1¼"
Adults 19-5509-04
4 cm/1½"



Sauer
19-5512-03
3 cm/1¼"



Barraquer
19-5510-04
4 cm/1½"



Bowman
19-5511-07
7 cm/2¾"



Goldstein
19-5513-03
3 cm/1¼"



Pley
19-5514-06
6 cm/2¼"

For left eye

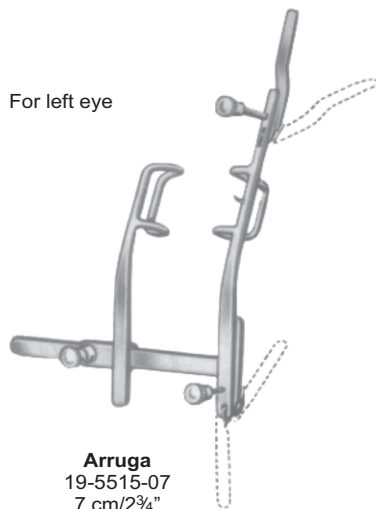

Arruga
19-5515-07
7 cm/2¾"

For right eye

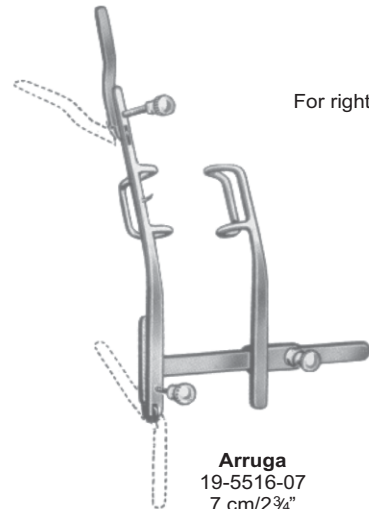

Arruga
19-5516-07
7 cm/2¾"

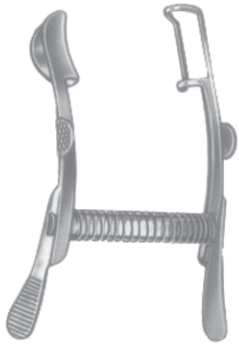

Mellinger-Axenfeld
19-5517-07
7 cm/2¾"



Mellinger-Axenfeld
19-5518-07
7 cm/2¾"



Children
19-5519-05
5 cm/2¾"



Mellinger
Adults
19-5520-07
7 cm/2¾"



Children
19-5521-05
5 cm/2"



Mellinger Beard Adults
19-5522-07
7 cm/2¾"



Knapp Clark
19-5523-08
8 cm/3¼"



Children
19-5524-06
6 cm/2½"



Graefe Adults
19-5525-09
9 cm/3½"



Lancaster
19-5526-08
8 cm/3¼"



Children
19-5527-07
7 cm/2¾"

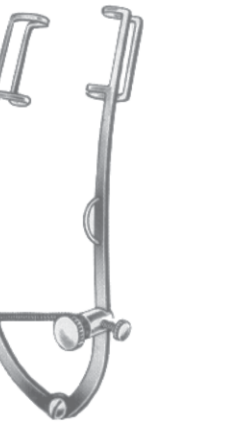

Williams Adults
19-5528-08
8 cm/3¼"



Lister-Burch
19-5529-08
8 cm/3¼"



Weiss
19-5530-08
8 cm/3¼"



Murdock
19-5531-05
5 cm/2"



Mueller
19-5532-07
7 cm/2¾"



Critchett
19-5533-06
6 cm/2½"



Castroviejo
19-5534-08
8 cm/3¼"



Schepens
19-5535-13
13 cm/5"



Desmarres
19-5536-13
13 cm/5"



8 mm

Conway
19-5537-13
13 cm/5"



Desmarres
13 cm/5"



19-5538-12
12 mm

19-5538-14
14 mm

19-5538-16
16 mm

19-5538-18
18 mm

Lid plate



Jaeger
19-5539-11
11 cm/4 1/2"

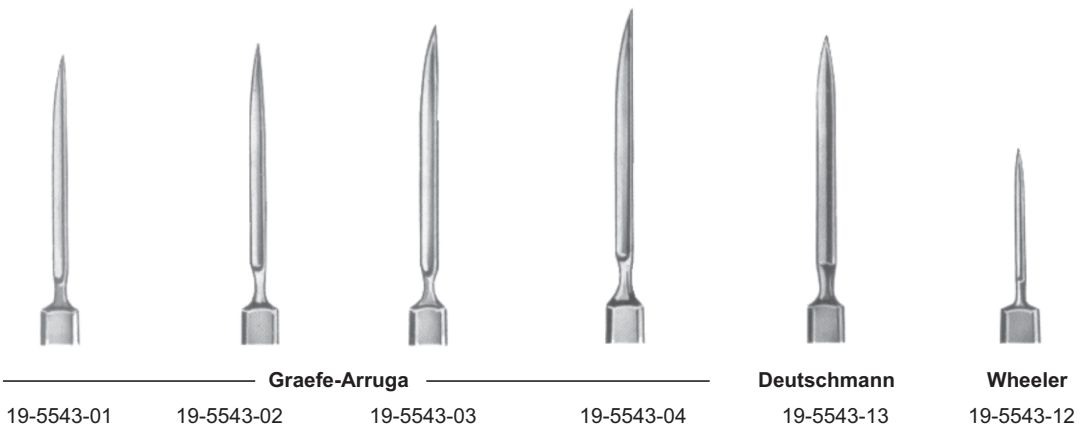
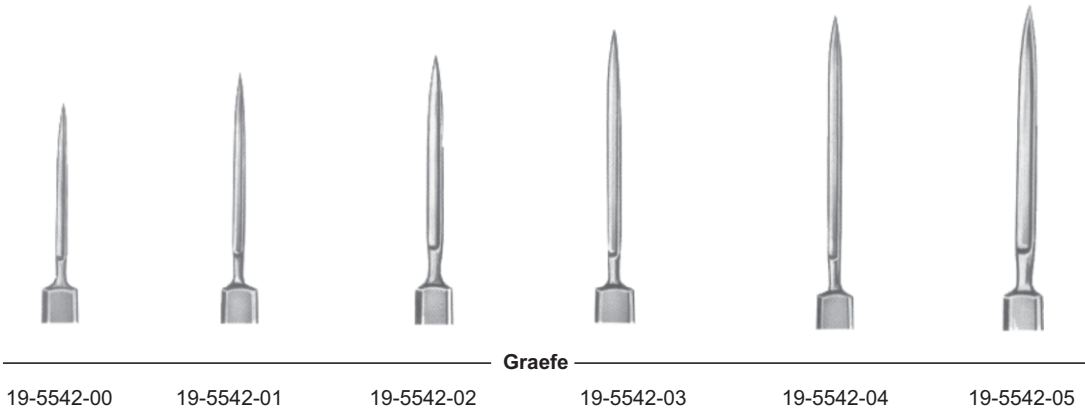
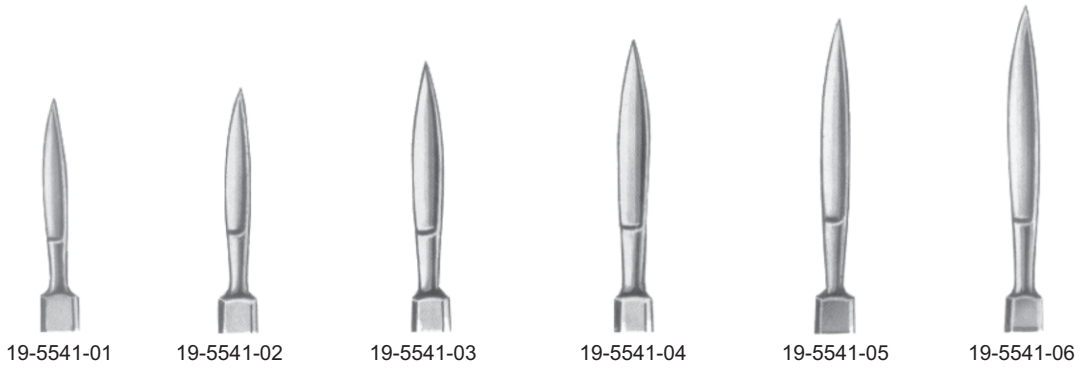



Jaeger
19-5544-01



19-5544-02



19-5544-03



19-5544-04



19-5545-01



19-5545-02



19-5545-03



19-5545-04



19-5546-01



19-5546-02



19-5546-03



19-5546-04



19-5547-01



19-5547-02



19-5547-03



19-5547-04



19-5548-01



19-5548-02



19-5548-03



19-5548-04

Jaeger-Grieshaber

Jaeger-Grieshaber



Wessely-Grieshaber

- 19-5549-01 4 mm
- 19-5549-02 5 mm
- 19-5549-03 6 mm
- 19-5549-04 7 mm

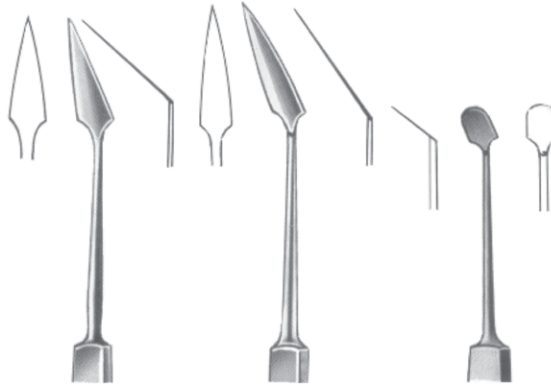

Wiener
19-5550-13

Berens
19-5551-13

Papst
19-5552-13



Castroviejo
19-5553-13



Castroviejo
19-5554-01
9 cm/3½"



Castroviejo
19-5555-02
9 cm/3½"



Castroviejo
19-5556-03
9 cm/3½"



OPHTHALMOLOGY
Various Eye Knives
Verschiedene Eye Messer
Varios cuchillos de ojos



Mod. Hamburg
19-5557-12



Graefe
19-5558-13



19-5559-01



Weber
19-5559-02



19-5559-03



Bowman
19-5560-04
0.4 mm



Bowman
19-5560-05
0.5 mm



Bowman
19-5560-06
0.6 mm



Bowman
19-5560-07
0.7 mm



Bowman
19-5560-08
0.8 mm

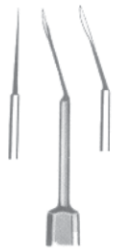

Bowman
Left 19-5561-01
Right 19-5561-02



19-5562-01



Knapp
19-5562-02



19-5562-03



19-5563-05
5 mm



Ziegler
19-5563-06
6 mm



19-5563-07
7 mm



Dean
19-5564-13



Zigler
19-5565-11
3½ mm



Sato
19-5566-12



Sichel
19-5567-13



Graefe
19-5568-13



Graefe
19-5569-13



Paton
19-5570-01



Kuhnt
19-5571-02



Desmarres
19-5572-03



Took
19-5573-04



Gill
19-5574-12



Elsching
19-5575-13



Took
19-5576-12



Desmarres
19-5577-01



Desmarres
19-5578-02



Desmarres
19-5579-03



Gill
19-5580-12



Guthrie
19-5581-12



Guthrie
19-5582-13



Berens
19-5583-12



**Knapp
Blunt**
19-5584-13



**Rollet
Sharp**
19-5585-12



Rollet
19-5586-12



**Fink
Blunt**
19-5587-12



10.5 cm/4 1/4"



Right
19-5588-01

Left
19-5588-02



Knapp-Rollet
19-5589-02



Flexible
19-5589-03



Flexible
19-5589-04



Axenfeld

Sharp
19-5590-14

Blunt
19-5591-14



Axenfeld

Sharp
19-5592-14

Blunt
19-5593-14



Paul
19-5594-12



Sautter
19-5595-01



Sautter
19-5596-02



Sautter
19-5597-03



Arruga
19-5598-13



Stevens
19-5599-14



Stevens
19-5600-12



Graefe
19-5601-01



Graefe
19-5602-02



Graefe
19-5603-03



Wecker
19-5604-13



Wecker
19-5605-13



Stock
19-5606-13



Stock
19-5607-13



Culler
19-5608-13



Suker
19-5609-14



OPHTHALMOLOGY

Enucleation Scoops and Chalazion Curettes
Enucleation Schaufeln und Chalazion Küretten
Enucleación Scoops y curetas Chalazión



Enucleation Scoops

Small
19-5610-16

Large
19-5610-20

Wells

Chalazion Curettes

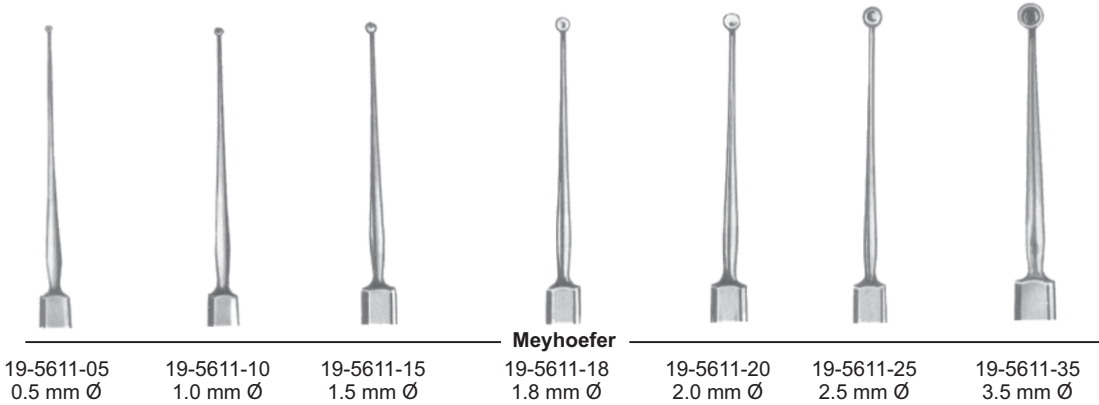

19-5611-05 0.5 mm Ø	19-5611-10 1.0 mm Ø	19-5611-15 1.5 mm Ø	Meyhoefer 19-5611-18 1.8 mm Ø	19-5611-20 2.0 mm Ø	19-5611-25 2.5 mm Ø	19-5611-35 3.5 mm Ø
------------------------	------------------------	------------------------	--	------------------------	------------------------	------------------------

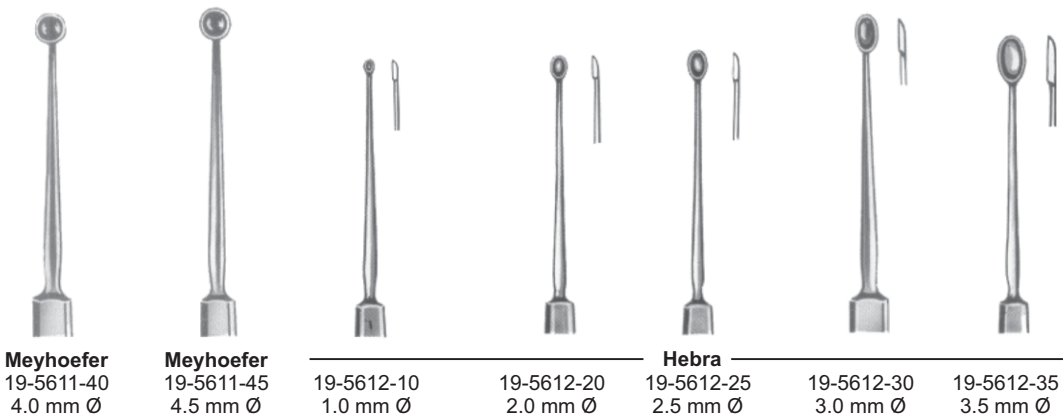

Meyhoefer 19-5611-40 4.0 mm Ø	Meyhoefer 19-5611-45 4.5 mm Ø	19-5612-10 1.0 mm Ø	19-5612-20 2.0 mm Ø	Hebra 19-5612-25 2.5 mm Ø	19-5612-30 3.0 mm Ø	19-5612-35 3.5 mm Ø
--	--	------------------------	------------------------	--	------------------------	------------------------



Exenteration Scoops

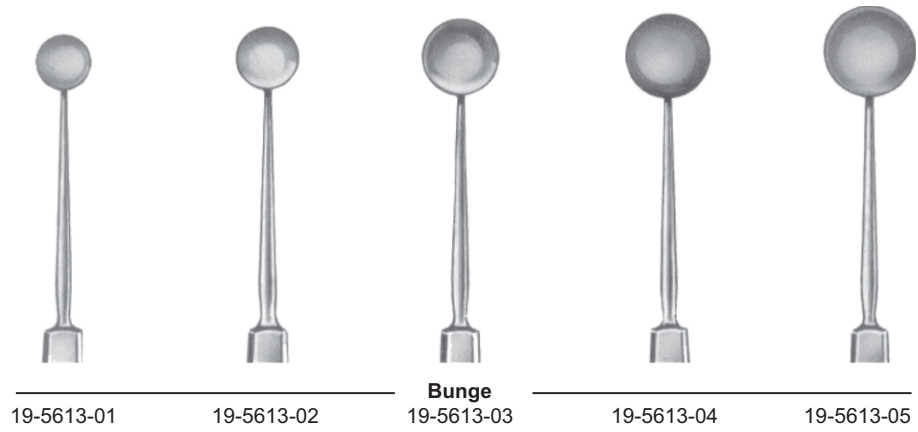

Axenfeld
 19-5614-13
 13 cm/5"



Lang
 19-5615-13
 13 cm/5"



Irrigating Cannulas

Straight



Binkhorst
19-5616-01
22 gauge

Right



Binkhorst
19-5617-02
22 gauge

Left



Binkhorst
19-5618-03
22 gauge



Bonn
19-5619-04
20 gauge



Bonn
19-5620-05
19 gauge



Hamburg
19-5621-06
23 gauge

Probe Point



Simcoe
19-5622-01
23 gauge

Irrigation/Aspiration Cannulas

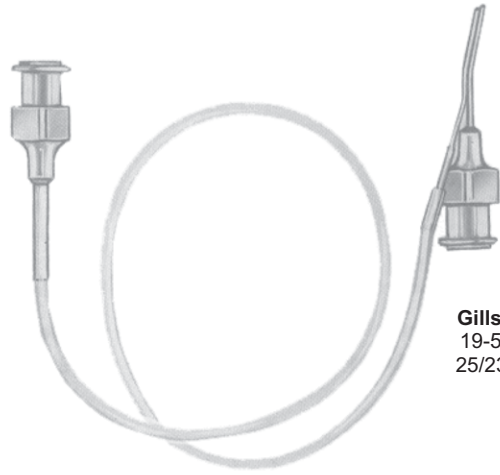

stotome Cannulas

Gills-Welsh
19-5623-02
25/23 gauge



Knolle-Kelmann
19-5624-01
22 gauge



Nevyas
19-5625-02
22 gauge



Kratz
19-5626-03
22 gauge



Freeman
19-5627-01
27 gauge

Lens Manipulation Cannulas



Irrigating Vectis Cannulas



Cortex Aspiration Cannulas

Capsule Polishing Cannulas

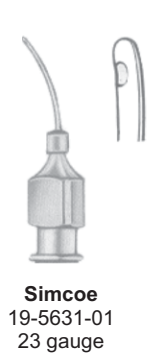



OPHTHALMOLOGY

Calipers, Markers, Punches Chisels, Marking instruments and Lachrymal Dilators
 Messschieber, Marker, Punches Meißel, Kennzeichnung Instrumente und Lachrymal Dilatoren
 Pinzas, marcadores, cinceles Punzones, los instrumentos de marcado y Dilatadores lagrimales



Castroviejo
19-5636-15



Castroviejo
19-5637-20
20 mm



Holth
19-5638-01



Haitz
19-5639-02



West
19-5640-16
16 cm/6 1/4"



West
19-5641-16
16 cm/6 1/4"



Connin-Amsler
19-5642-13
13 cm/5"



Wilder
19-5643-01



Wilder
19-5644-02



Wilder
19-5645-03

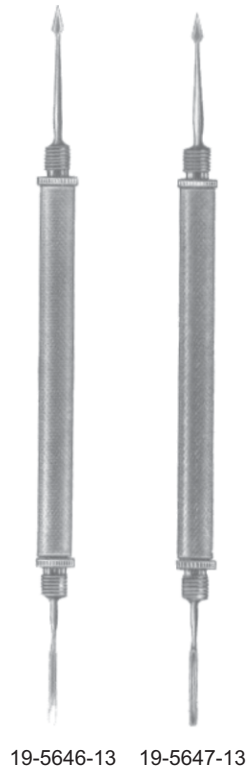

Neddle Only
19-5648-01

Chisel Only
19-5648-02

Gouge Only
19-5648-03



19-5649-13

Instrumentation for D. B. Kirby Operations



19-5650-10



Teeth
19-5651-10 1:2 Teeth
19-5652-10 2:3 Teeth



19-5653-10
1 : 2



Kirby
19-5654-10
10 cm/4"



Kirby
19-5655-10
10 cm/4"



19-5656-10



19-5657-10



Tuebingen
19-5658-10
10 cm/4"



19-5659-08
8.5 cm/3 1/2"



Paufigue
19-5660-10
10 cm/4"



Barraquer
19-5661-10
10.5 cm/4 1/4"



McPherson
19-5662-10
10 cm/4"



McPherson
19-5663-07
7.5 cm/3"



McCullough
 19-5664-09
 9.5 cm/3 3/4"



McCullough
 19-5665-09
 9.5 cm/3 3/4"



Bonaccoito
 19-5666-10
 10 cm/4"



Bonaccoito
 19-5667-10
 10 cm/4"



19-5668-11
 11 cm/4 1/2"



11 cm/4 1/2"



19-5669-11
 1 : 2



19-5670-11
 2 : 3



Nugent
 10 cm/4"



19-5671-01



19-5672-02



OPHTHALMOLOGY

Strabismus, Muscle and Advancement Forceps
Strabismus, Muskel-und Advancement Zange
Estrabismo, los músculos y Promoción Pinzas

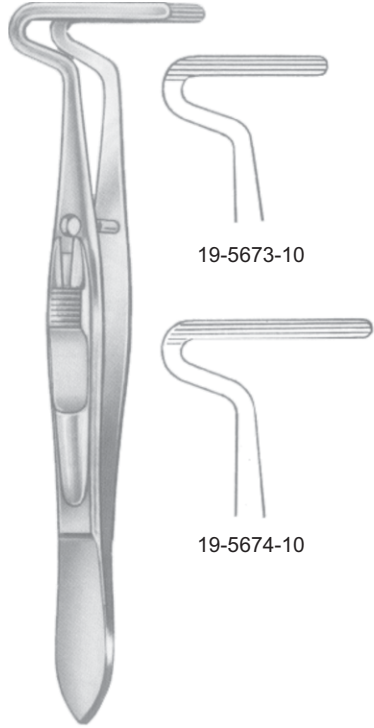

19-5673-10

19-5674-10

Berke
10 cm/4"



Blascovics
19-5675-09
9 cm/3 1/2"



Blascovics
19-5676-09
9 cm/3 1/2"



Worth
19-5677-10
10 cm/4"



Worth
19-5678-10
10 cm/4"



Jameson
19-5679-10
10 cm/4"



Jameson
19-5680-10
10 cm/4"



Prince
19-5681-10
10 cm/4"



Prince
19-5682-10
10 cm/4"



Snellen
 19-5683-10
 10 cm/4"



Snellen
 19-5684-10
 10 cm/4"



Erhardt
 19-5685-09
 9 cm/3 1/2"

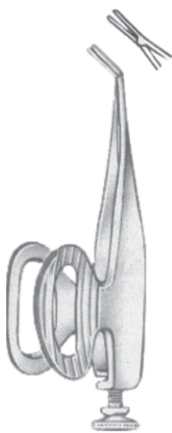

Barraquer
 19-5686-05
 5.5 cm/2 1/4"

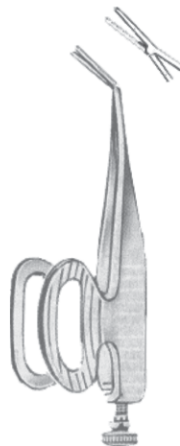

Barraquer
 19-5687-07
 5.5 cm/2 1/4"



Barraquer
 19-5688-10
 5.5 cm/2 1/4"



10 x

With guide pin

1:2
Bonn
19-5689-07
7 cm/2 3/4"

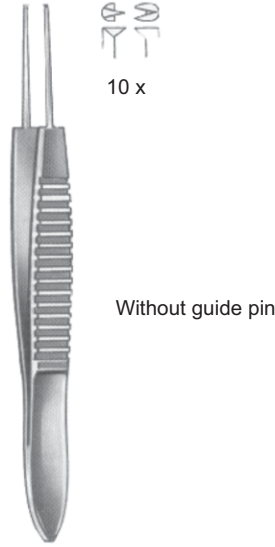

10 x

Without guide pin

1:2
Bonn
19-5690-07
7 cm/2 3/4"

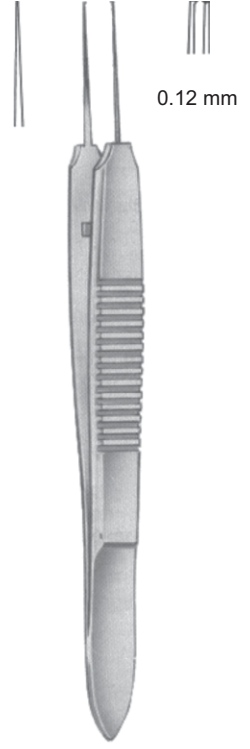

0.12 mm

Bonn
19-5691-10
10 cm/4"



Bishop-Harman
19-5692-08
8.5 cm/3 1/2"



Bishop-Harman
19-5693-08
8.5 cm/3 1/2"



fine

Bishop-Harman
19-5694-08
8.5 cm/3 1/2"



10 x
fine

1:2
Bishop-Harman
19-5695-08
8.5 cm/3 1/2"



Graefe
10 cm/4"



19-5696-10



19-5697-10



19-5698-10



19-5699-10



19-5700-10



19-5701-10

Conjunctival forceps



Stevens
10.5 cm/4¼"



19-5702-10



19-5703-10



19-5704-10



O'Connor
19-5708-10
10 cm/4"



19-5705-10



19-5706-10



19-5707-10



Stevens
19-5709-11
11 cm/4½"



Stevens
19-5710-11
11 cm/4½"



Fischer
19-5711-07
7 cm/2 3/4"



Fischer-Arit
19-5712-07
7 cm/2 3/4"



Hess
19-5713-07
7 cm/2 3/4"



Hess
19-5714-07
7 cm/2 3/4"



Smooth **Chandler** Serrated
19-5715-01 7 cm/2 3/4" 19-5716-02



Fuchs
19-5717-07
7 cm/2 3/4"



Gill-Hess
19-5718-07
7.5 cm/3"



Gill-Hess Teeth Below
19-5719-07 7.5 cm/3"
19-5720-07 Teeth on side



Barraquer-Katzin
(Colibri)
19-5721-07
7 cm/2 3/4"





Fuchs
19-5722-07
7 cm/2 3/4"



Kalt
19-5723-10
10 cm/4"



Terson
19-5724-09
9.5 cm/3 3/4"



Arruga-Nizetic
19-5725-10
10 cm/4"



Castroviejo
19-5726-10
10 cm/4"



Castroviejo
19-5727-10
10 cm/4"



Elschnig
19-5728-10
10 cm/4"

For Len Implantation



Binkhorst
19-5729-07
7 cm/2 3/4"



Arruga
19-5730-09
9.5 cm/3 3/4"



Arruga
19-5731-09
9.5 cm/3 3/4"



Knapp
19-5732-11
11 cm/4¼"



Ayer
19-5733-09
9 cm/3½"



Ayer
19-5734-09
9 cm/3½"



Lambert
19-5735-09
9 cm/3½"



Desmarres
9 cm/3½"



19-5736-01



19-5737-02



19-5738-03



Fig. 1



Fig. 2



Fig. 3

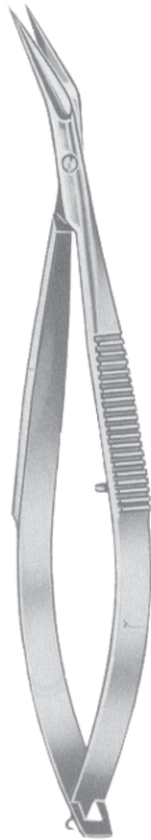

Noyes
19-5740-12
12 cm/4 3/4"



Wecker
19-5743-05
11.5 cm/4 1/2"



19-5741-01



19-5742-02



Barraquer
19-5743-05
5.5 cm/2 1/4"

Noyes
Fig.1 19-5739-01
Fig.2 19-5739-02
Fig.3 19-5739-03
12 cm/4 3/4"



19-5744-09
9 cm/3 1/2"



19-5745-09



19-5746-09



19-5747-09



19-5748-09



19-5749-09

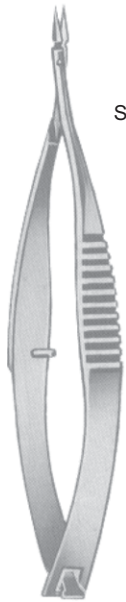

Straight

Vannas
19-5750-08
8 cm/3 1/4"

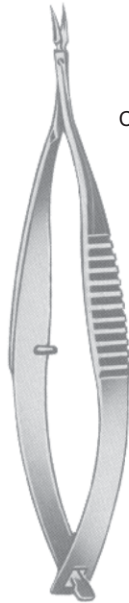

Curved

Vannas
19-5751-08
8 cm/3 1/4"

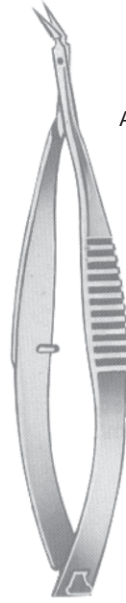

Angular

Vannas
19-5752-08
8 cm/3 1/4"

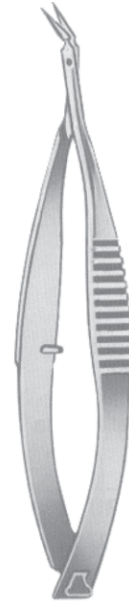

Vannas
19-5753-08
8 cm/3 1/4"



Straight

19-5754-08
8.5 cm/3 1/4"



Curved

19-5755-08
8.5 cm/3 1/4"

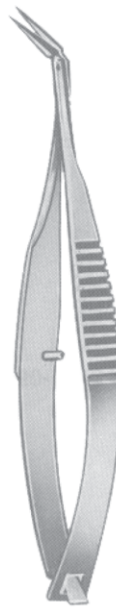

Angular

19-5756-08
8.5 cm/3 1/4"

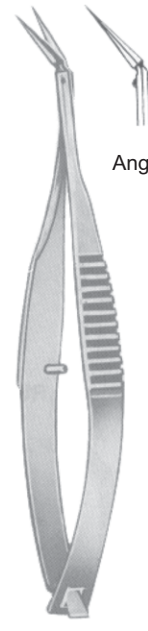

Angular

19-5757-08
8.5 cm/3 1/4"

Vannas Mod, Tubingen



19-5758-10
10 cm/4"



19-5759-10
10 cm/4"



Castroviejo
19-5760-10
10 cm/4"



Castroviejo
19-5761-10
10 cm/4"



Aebli
19-5762-10
10 cm/4"



Castroviejo
19-5763-10
10 cm/4"



Castroviejo
19-5764-10
10 cm/4"

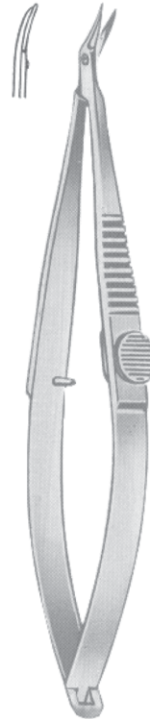

Troutman-Barraquer
19-5765-10
10 cm/4"



Troutman-Barraquer
19-5766-10
10 cm/4"

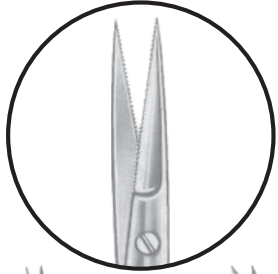

Saw Edge

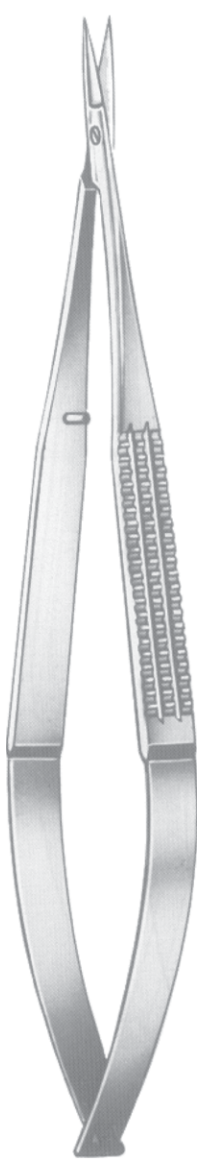

Straight
19-5767-16
16cm/6 1/4"

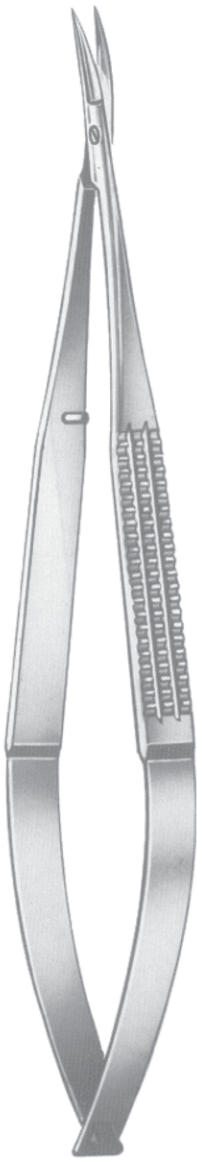

Curved
19-5768-16
16cm/6 1/4"

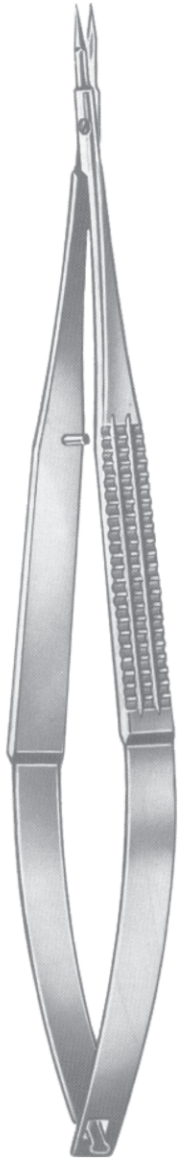

Straight
19-5769-16
16cm/6 1/4"

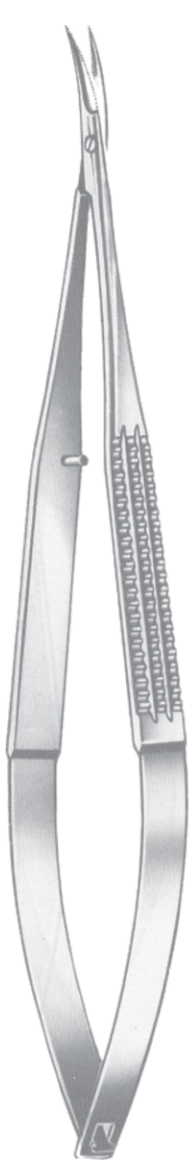

Curved
19-5770-16
16cm/6 1/4"

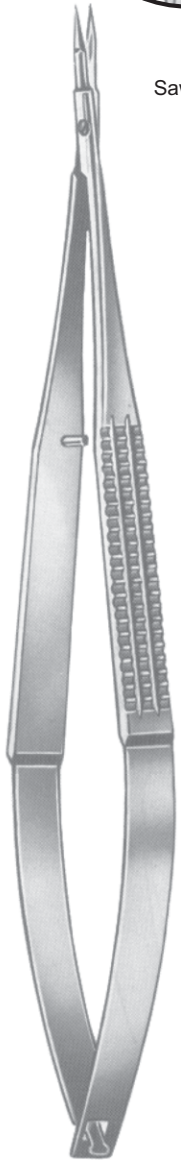

Millesi
Straight
19-5771-16
16cm/6 1/4"

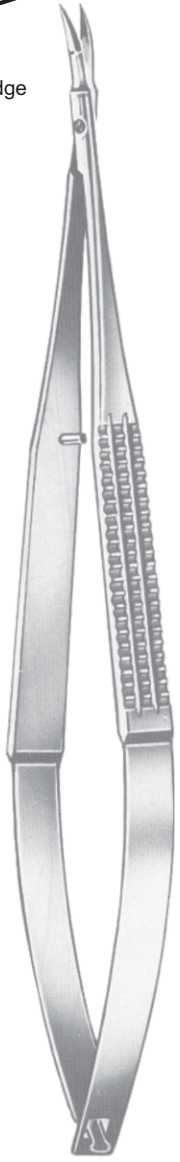

Millesi
Curved
19-5772-16
16cm/6 1/4"



Straight
 19-5773-18
 18.5cm/7 1/4"

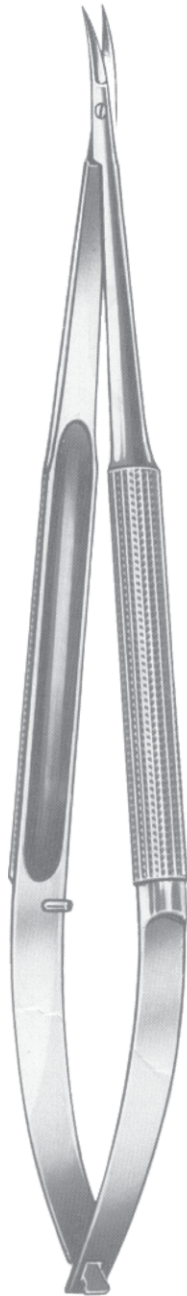

Curved
 19-5774-18
 18.5cm/7 1/4"

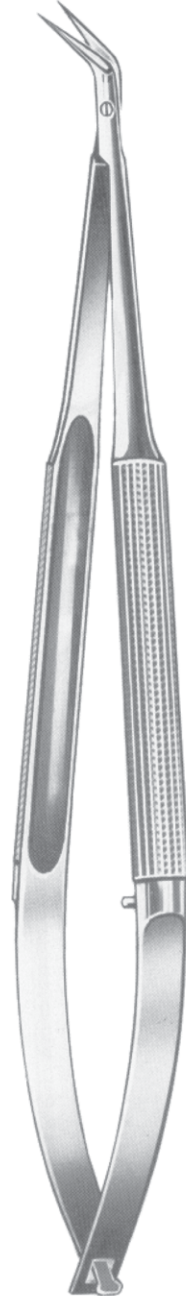

Angular
 19-5775-18
 18.5cm/7 1/4"



Straight
 19-5776-23
 23cm/9"



Dissecting Scissors



Straight
19-5777-14
14.5cm/5 3/4"



Curved
19-5778-14
14.5cm/5 3/4"



Curved
19-5779-14
14.5cm/5 3/4"