



nadeem
SURGICAL CORPORATION (PVT) LTD.



26

EN

Gynecology

DE

Gynäkologie

ES

Ginecología

Page 517 to 556



Scheme of Dimensions for Specula

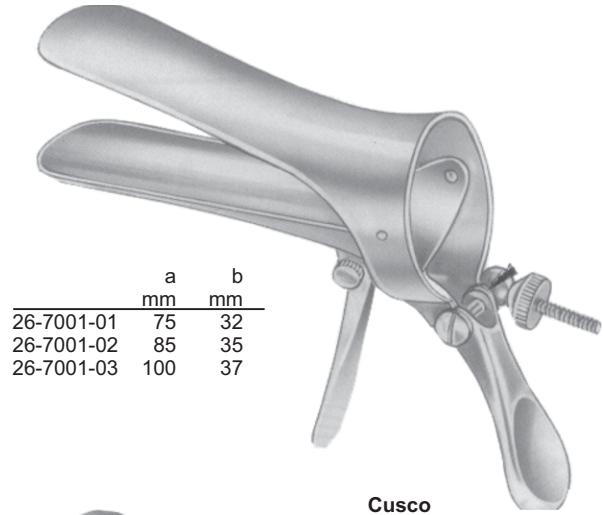
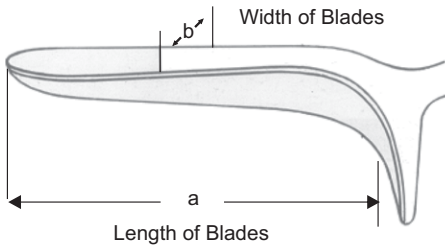

Cusco

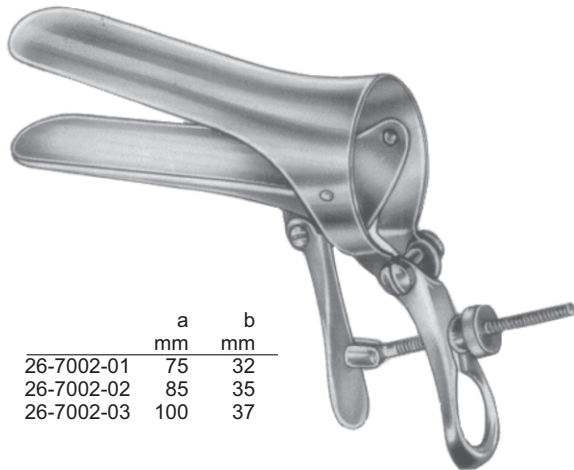

Cusco

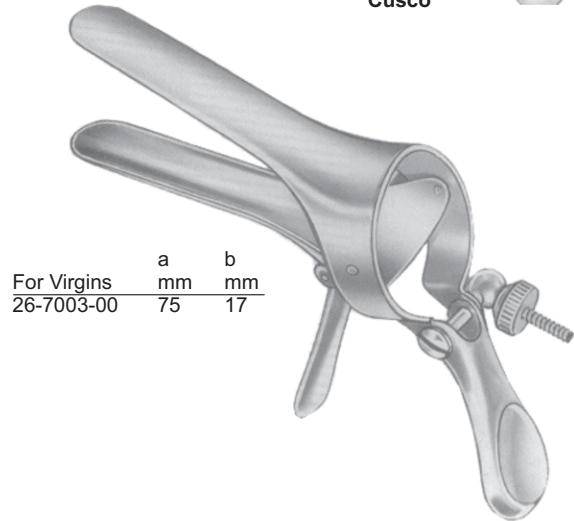

Cusco

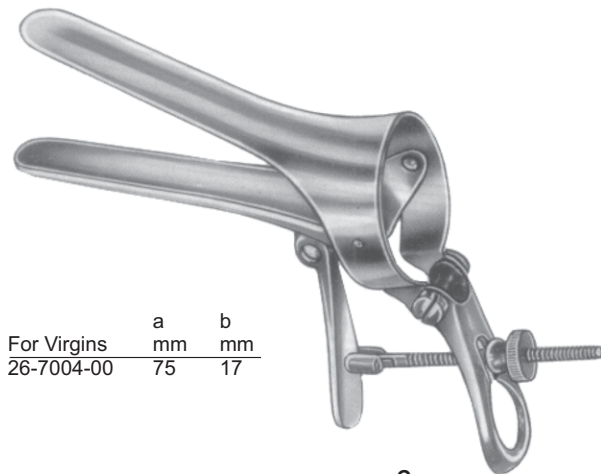

Cusco

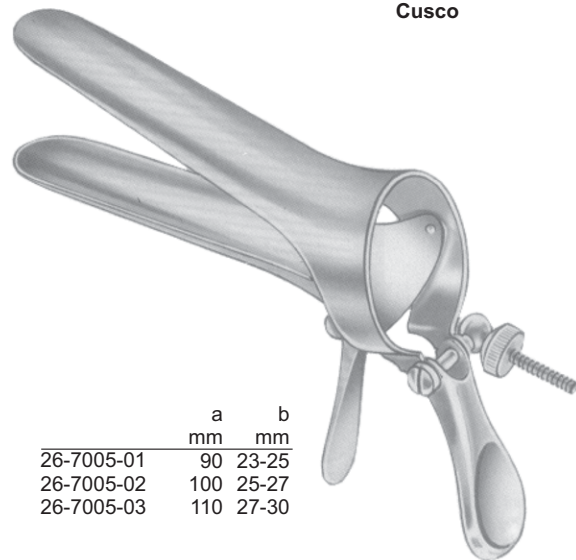

**Cusco
 Swiss Pattern**

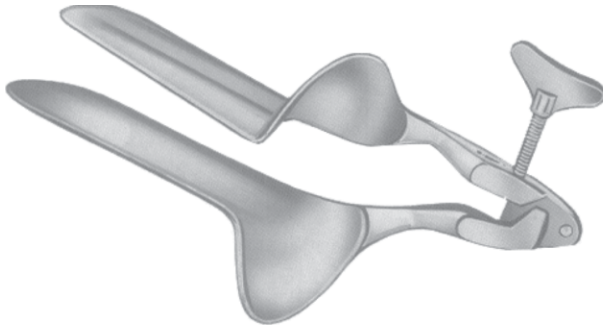

Collin-Landau

| | | |
|--------|------------|-------------|
| Small | 26-7006-01 | 30 x 85 mm |
| Medium | 26-7006-02 | 35 x 100 mm |
| Large | 26-7006-03 | 40 x 110 mm |

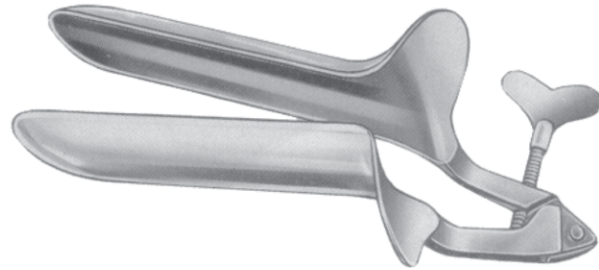

Collin

| | | |
|--------|------------|-------------|
| Small | 26-7007-01 | 30 x 85 mm |
| Medium | 26-7007-02 | 35 x 100 mm |
| Large | 26-7007-03 | 40 x 110 mm |

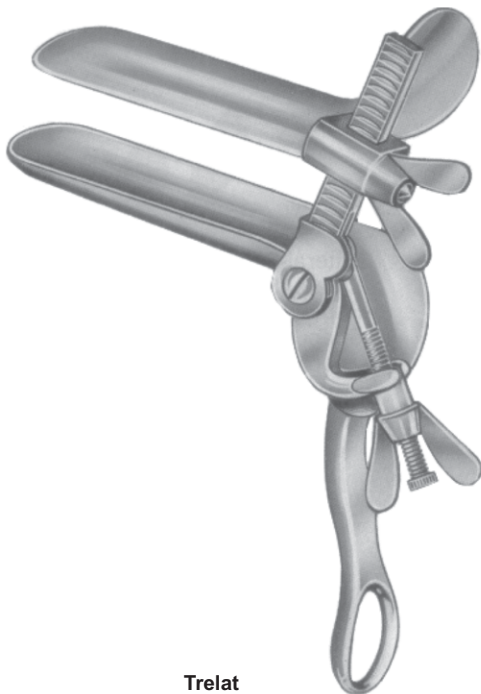

Trelat

| | a mm | b mm |
|------------|---------|---------|
| 26-7008-01 | 85 | 33 |
| 26-7008-02 | 95 | 35 |
| 26-7008-03 | 115 | 43 |

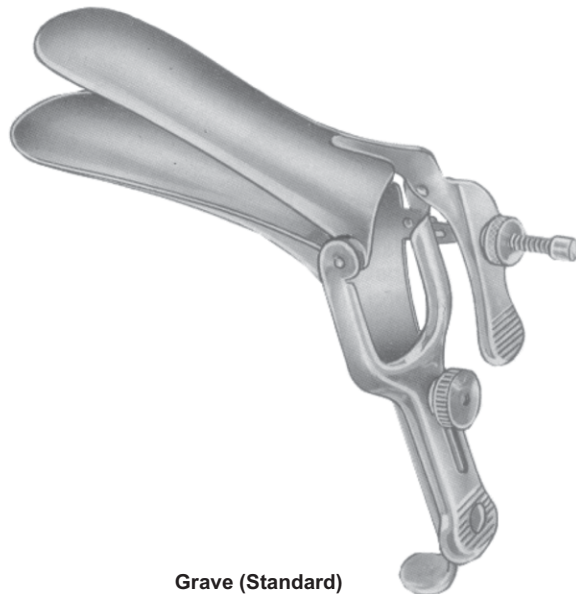

Grave (Standard)

| | a mm | b mm |
|------------|---------|---------|
| 26-7009-01 | 75 | 20 |
| 26-7009-02 | 95 | 30 |
| 26-7009-03 | 115 | 35 |
| 26-7009-04 | 125 | 35 |



Black



| Grave | a | b |
|--------------|-----|----|
| | mm | mm |
| 26-7010-01 | 75 | 20 |
| 26-7010-02 | 95 | 35 |
| 26-7010-03 | 115 | 35 |

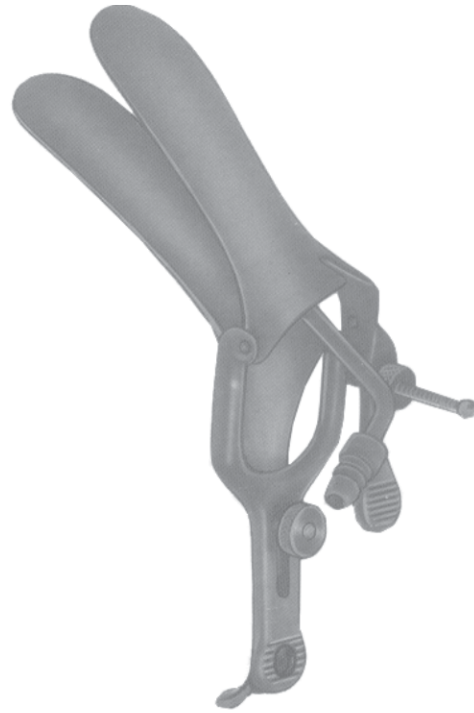

| Grave | a | b |
|--------------|-----|----|
| Angled 135° | mm | mm |
| 26-7011-00 | 101 | 35 |

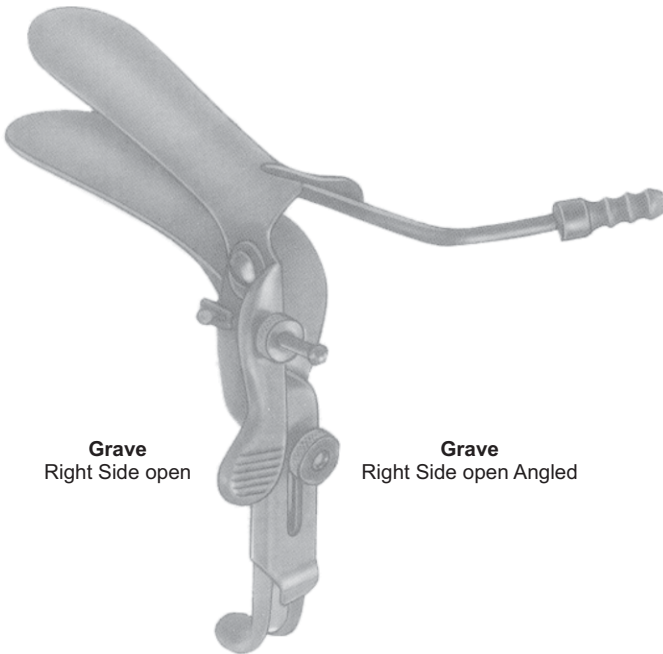

Grave
Right Side open

Grave
Right Side open Angled

26-7012-01

26-7012-02

| a | b |
|-----|----|
| mm | mm |
| 101 | 35 |

Lateral Specula



26-7013-00



Pederson

| | a mm | b mm |
|------------|---------|---------|
| 26-7014-01 | 75 | 13 |
| 26-7014-02 | 100 | 22 |
| 26-7014-03 | 120 | 25 |

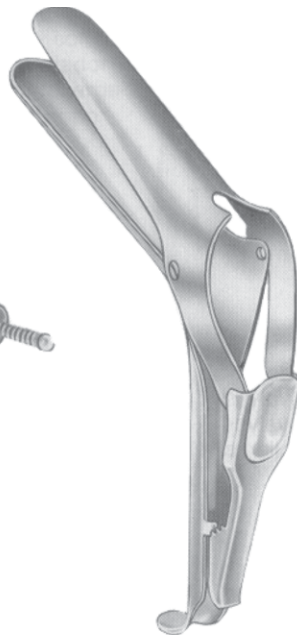

Semm

| | a mm | b mm |
|------------|---------|---------|
| 26-7015-01 | 90 | 14/18 |
| 26-7015-02 | 100 | 17/20 |
| 26-7015-03 | 100 | 25/30 |



Nott

| | a mm | b mm |
|------------|---------|---------|
| 26-7016-01 | 90 | 30 |
| 26-7016-02 | 110 | 30 |

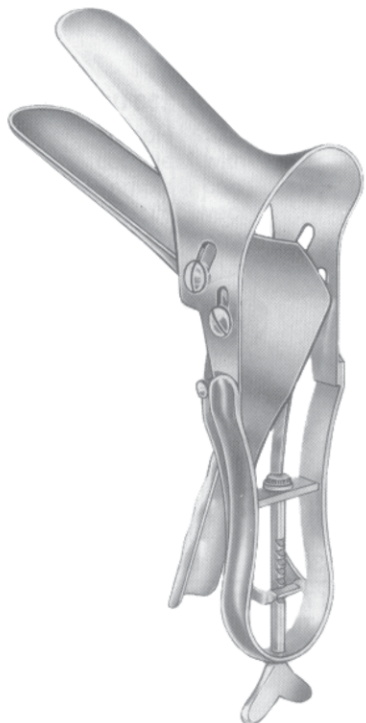

Seyffert

| | a mm | b mm |
|------------|---------|---------|
| 26-7017-01 | 100 | 17 |
| 26-7017-02 | 110 | 33 |

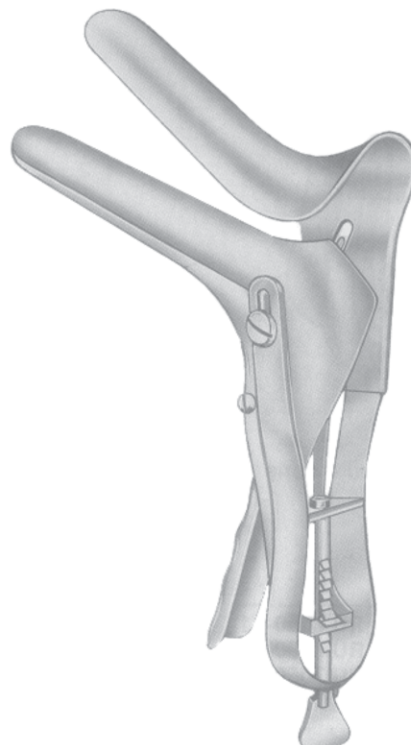

One Side open

Seyffert

| | a mm | b mm |
|------------|---------|---------|
| 26-7018-02 | 110 | 33 |



Scheme of Dimensions for Specula

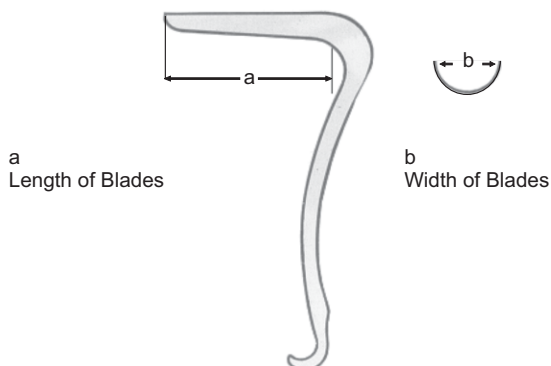

a
Length of Blades

b
Width of Blades



Sims (single ended)

| | |
|------------|------------|
| 26-7019-01 | 63 x 32 mm |
| 26-7019-02 | 76 x 32 mm |
| 26-7019-03 | 89 x 38 mm |

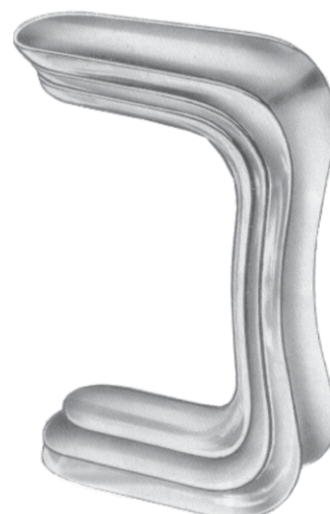

Sims (double ended)

| | |
|------------|-------------------------|
| 26-7020-01 | 26 x 70 mm (30 x 75 mm) |
| 26-7020-02 | 30 x 75 mm (35 x 80 mm) |
| 26-7020-03 | 36 x 80 mm (40 x 90 mm) |



Jackson

| | Fig. | a mm | b mm |
|------------|------|----------|---------|
| 26-7021-01 | 1 | 75 X 40 | |
| 26-7021-02 | 2 | 90 X 40 | |
| 26-7021-03 | 3 | 100 X 40 | |



Eastman

| | Fig. | a mm | b mm |
|------------|------|---------|---------|
| 26-7022-01 | 1 | 76 | 38 |
| 26-7022-02 | 2 | 89 | 38 |
| 26-7022-03 | 3 | 101 | 38 |

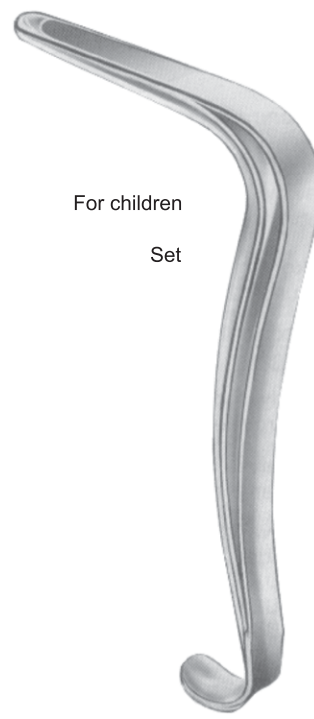

For children

Set

Kristeller
26-7023-00
70x15 mm

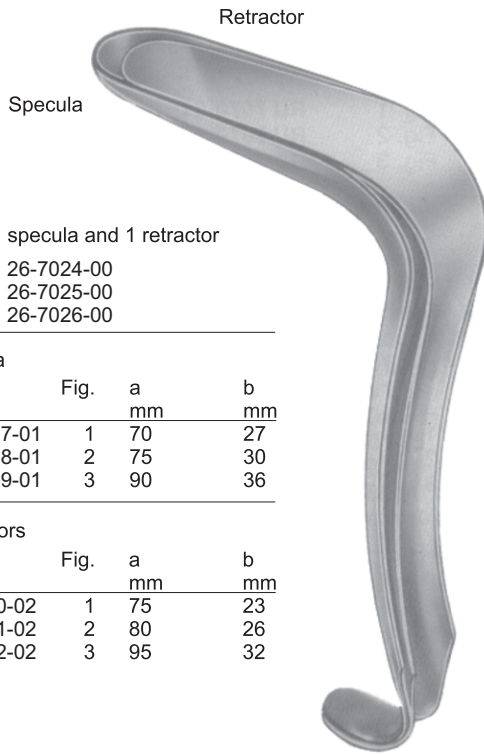

Set of 1 specula and 1 retractor

- Fig. 1 26-7024-00
- Fig. 2 26-7025-00
- Fig. 3 26-7026-00

Specula

| | Fig. | a mm | b mm |
|------------|------|---------|---------|
| 26-7027-01 | 1 | 70 | 27 |
| 26-7028-01 | 2 | 75 | 30 |
| 26-7029-01 | 3 | 90 | 36 |

Retractors

| | Fig. | a mm | b mm |
|------------|------|---------|---------|
| 26-7030-02 | 1 | 75 | 23 |
| 26-7031-02 | 2 | 80 | 26 |
| 26-7032-02 | 3 | 95 | 32 |

**Kristeller
(Standard)**

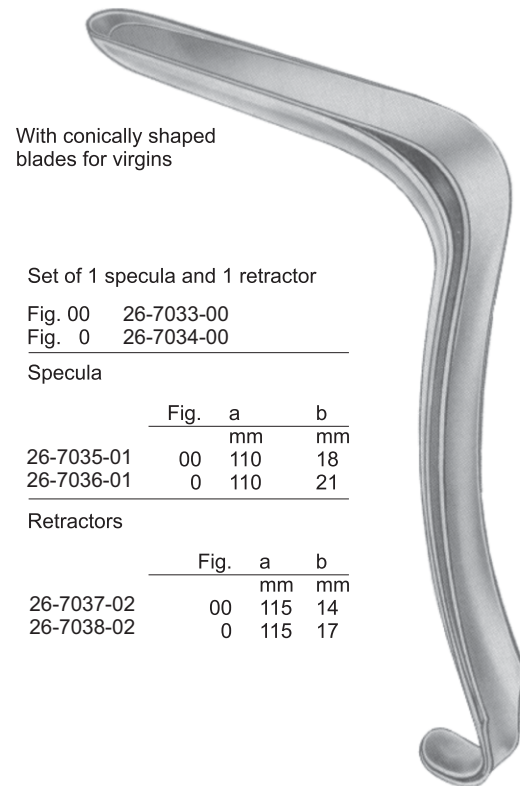

Set of 1 specula and 1 retractor

- Fig. 00 26-7033-00
- Fig. 0 26-7034-00

Specula

| | Fig. | a mm | b mm |
|------------|------|---------|---------|
| 26-7035-01 | 00 | 110 | 18 |
| 26-7036-01 | 0 | 110 | 21 |

Retractors

| | Fig. | a mm | b mm |
|------------|------|---------|---------|
| 26-7037-02 | 00 | 115 | 14 |
| 26-7038-02 | 0 | 115 | 17 |

Kristeller

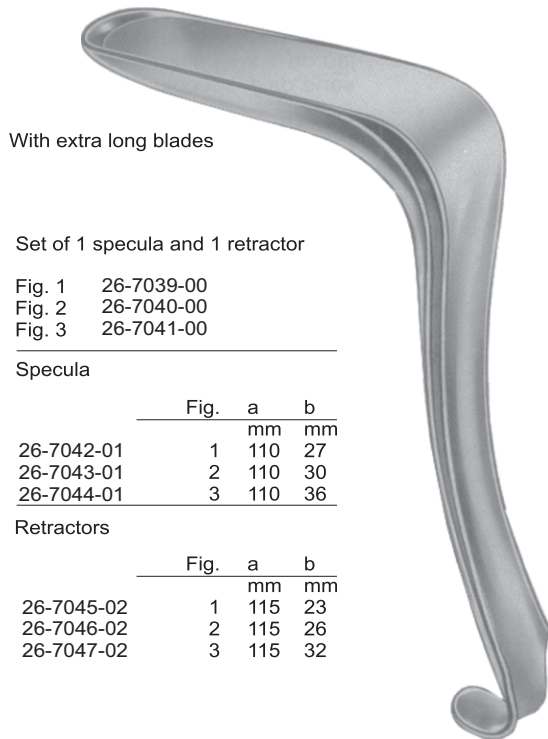

Set of 1 specula and 1 retractor

- Fig. 1 26-7039-00
- Fig. 2 26-7040-00
- Fig. 3 26-7041-00

Specula

| | Fig. | a mm | b mm |
|------------|------|---------|---------|
| 26-7042-01 | 1 | 110 | 27 |
| 26-7043-01 | 2 | 110 | 30 |
| 26-7044-01 | 3 | 110 | 36 |

Retractors

| | Fig. | a mm | b mm |
|------------|------|---------|---------|
| 26-7045-02 | 1 | 115 | 23 |
| 26-7046-02 | 2 | 115 | 26 |
| 26-7047-02 | 3 | 115 | 32 |

**Kristeller
(Standard)**

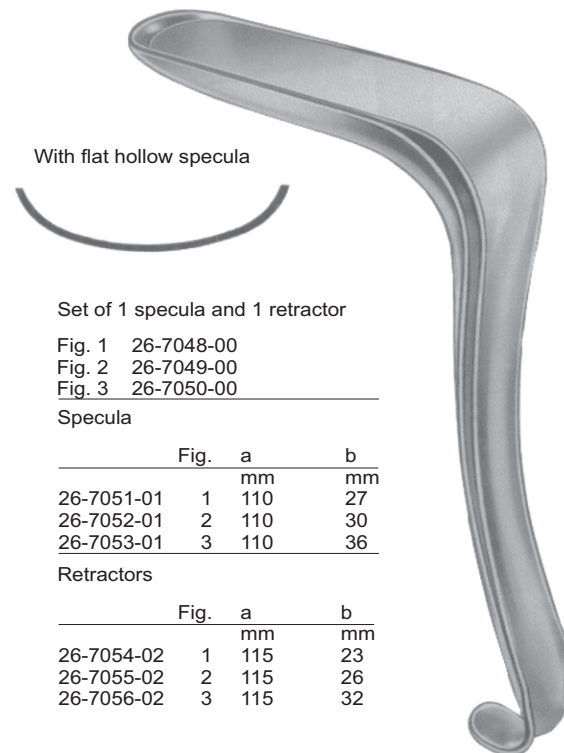

Set of 1 specula and 1 retractor

- Fig. 1 26-7048-00
- Fig. 2 26-7049-00
- Fig. 3 26-7050-00

Specula

| | Fig. | a mm | b mm |
|------------|------|---------|---------|
| 26-7051-01 | 1 | 110 | 27 |
| 26-7052-01 | 2 | 110 | 30 |
| 26-7053-01 | 3 | 110 | 36 |

Retractors

| | Fig. | a mm | b mm |
|------------|------|---------|---------|
| 26-7054-02 | 1 | 115 | 23 |
| 26-7055-02 | 2 | 115 | 26 |
| 26-7056-02 | 3 | 115 | 32 |

Kristeller



GYNECOLOGY

Vaginal Speculums and Retractors
Scheidenspekula und -halter
Especúlos y Valvas vaginales



| | a | b |
|------------|-----|----|
| | mm | mm |
| 26-7057-20 | 100 | 20 |
| 26-7057-25 | 100 | 25 |
| 26-7057-30 | 100 | 30 |
| 26-7057-35 | 100 | 35 |
| 26-7057-40 | 100 | 40 |
| 26-7058-20 | 130 | 20 |
| 26-7058-25 | 130 | 25 |
| 26-7058-30 | 130 | 30 |
| 26-7058-35 | 130 | 35 |
| 26-7058-40 | 130 | 40 |

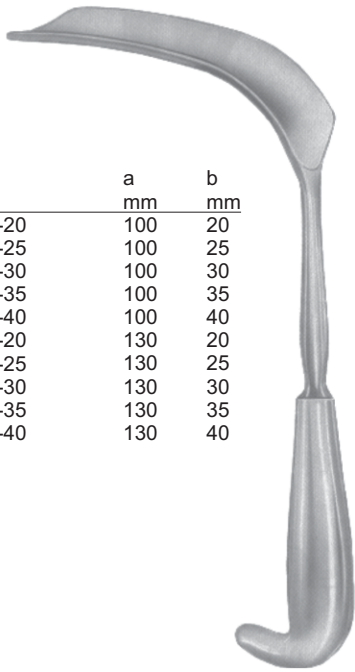

Matzenauer



Braun
26-7059-18
18 cm/7"
56x13 mm



Braun
26-7060-18
18 cm/7"
60x10 mm



Ulrich
26-7061-19
19,5 cm/7½"
80x20 mm



26-7062-19
19 cm/7½"
85x17 mm

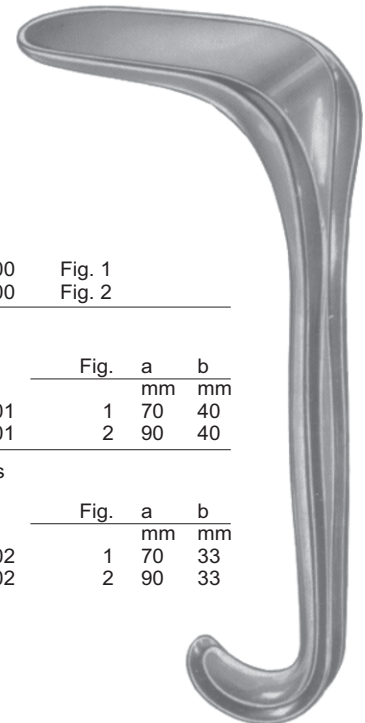

Set

- 26-7063-00 Fig. 1
- 26-7064-00 Fig. 2

Specula

| | Fig. | a | b |
|------------|------|----|----|
| | | mm | mm |
| 26-7065-01 | 1 | 70 | 40 |
| 26-7066-01 | 2 | 90 | 40 |

Retractors

| | Fig. | a | b |
|------------|------|----|----|
| | | mm | mm |
| 26-7067-02 | 1 | 70 | 33 |
| 26-7068-02 | 2 | 90 | 33 |

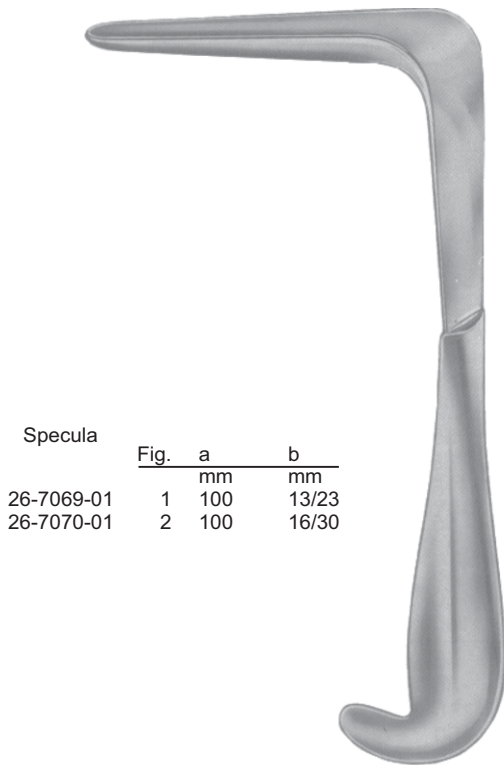

| Specula | Fig. | a | b |
|------------|------|-----|-------|
| | | mm | mm |
| 26-7069-01 | 1 | 100 | 13/23 |
| 26-7070-01 | 2 | 100 | 16/30 |

Mathieu

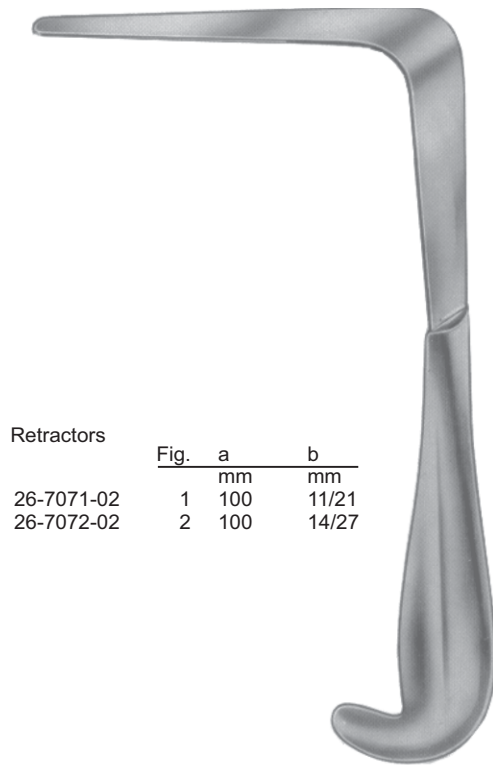

| Retractors | Fig. | a | b |
|------------|------|-----|-------|
| | | mm | mm |
| 26-7071-02 | 1 | 100 | 11/21 |
| 26-7072-02 | 2 | 100 | 14/27 |

Mathieu



| | Fig. | a | b |
|------------|------|-----|----|
| | | mm | mm |
| 26-7073-01 | 1 | 75 | 45 |
| 26-7073-02 | 2 | 90 | 45 |
| 26-7073-03 | 3 | 110 | 45 |

Doyen



| | |
|------------|-------------|
| 26-7074-01 | 75 x 280mm |
| 26-7074-02 | 90 x 280mm |
| 26-7074-03 | 100 x 280mm |
| 26-7074-03 | 115 x 280mm |

Doyen
 Hollow handle 28cm/11"

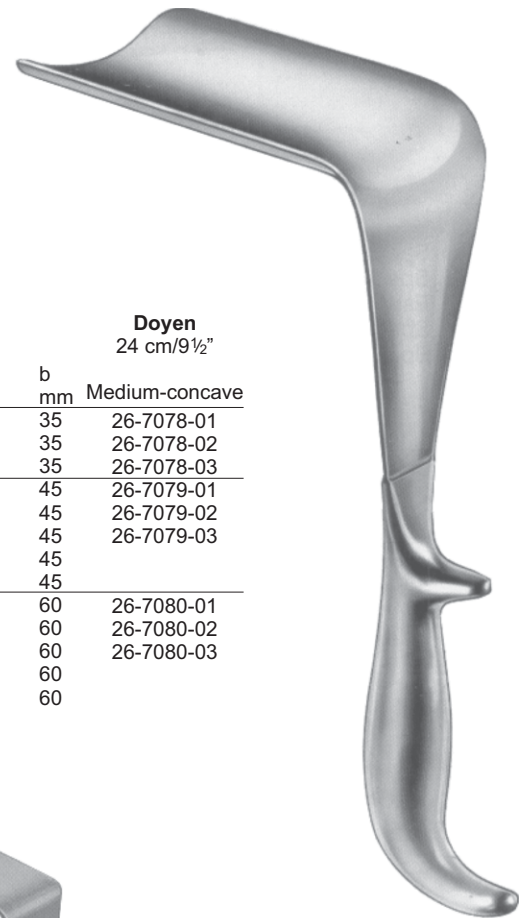

| Doyen 24 cm/9½" | | Fig. | a mm | b mm | Doyen 24 cm/9½" | |
|--------------------|---|------|---------|------------|--------------------|--|
| slightly-concave | | | | | Medium-concave | |
| 26-7075-01 | 1 | 55 | 35 | 26-7078-01 | | |
| 26-7075-02 | 2 | 85 | 35 | 26-7078-02 | | |
| 26-7075-03 | 3 | 115 | 35 | 26-7078-03 | | |
| 26-7076-01 | 1 | 55 | 45 | 26-7079-01 | | |
| 26-7076-02 | 2 | 85 | 45 | 26-7079-02 | | |
| 26-7076-03 | 3 | 115 | 45 | 26-7079-03 | | |
| 26-7076-04 | 4 | 160 | 45 | | | |
| 26-7076-05 | 5 | 180 | 45 | | | |
| 26-7077-01 | 1 | 55 | 60 | 26-7080-01 | | |
| 26-7077-02 | 2 | 85 | 60 | 26-7080-02 | | |
| 26-7077-03 | 3 | 115 | 60 | 26-7080-03 | | |
| 26-7077-04 | 4 | 160 | 60 | | | |
| 26-7077-05 | 5 | 180 | 60 | | | |



| Doyen 25 cm/10" | | |
|--------------------|---------|---------|
| | a mm | b mm |
| 26-7081-01 | 60 | 30 |
| 26-7081-02 | 70 | 30 |
| 26-7081-03 | 80 | 30 |



Auvard
 with removable weight
 26-7082-01
 80x38 mm
 26-7082-02
 105x42 mm



Auvard
 with fixed weight
 26-7083-01
 70x38 mm
 26-7083-02
 102x45 mm



Landau

| | a mm | b mm |
|------------|---------|---------|
| 26-7084-01 | 100 | 28 |
| 26-7084-02 | 100 | 38 |



Breisky

| | a mm | b mm |
|------------|---------|---------|
| 26-7085-20 | 100 | 20 |
| 26-7085-25 | 100 | 25 |
| 26-7085-30 | 100 | 30 |
| 26-7085-35 | 100 | 35 |
| 26-7085-40 | 100 | 40 |
| 26-7086-20 | 130 | 20 |
| 26-7086-25 | 130 | 25 |
| 26-7086-30 | 130 | 30 |
| 26-7086-35 | 130 | 35 |
| 26-7086-40 | 130 | 40 |
| 26-7087-20 | 160 | 20 |
| 26-7087-25 | 160 | 25 |
| 26-7087-30 | 160 | 30 |
| 26-7087-35 | 160 | 35 |
| 26-7087-40 | 160 | 40 |
| 26-7088-20 | 180 | 20 |
| 26-7088-25 | 180 | 25 |
| 26-7088-30 | 180 | 30 |
| 26-7088-35 | 180 | 35 |
| 26-7088-40 | 180 | 40 |



Gelpi
Vulva self retaining
26-7089-20 20cm/8"



Comyn Berkeley
Vulva self retaining
26-7090-15 15.5cm/6"

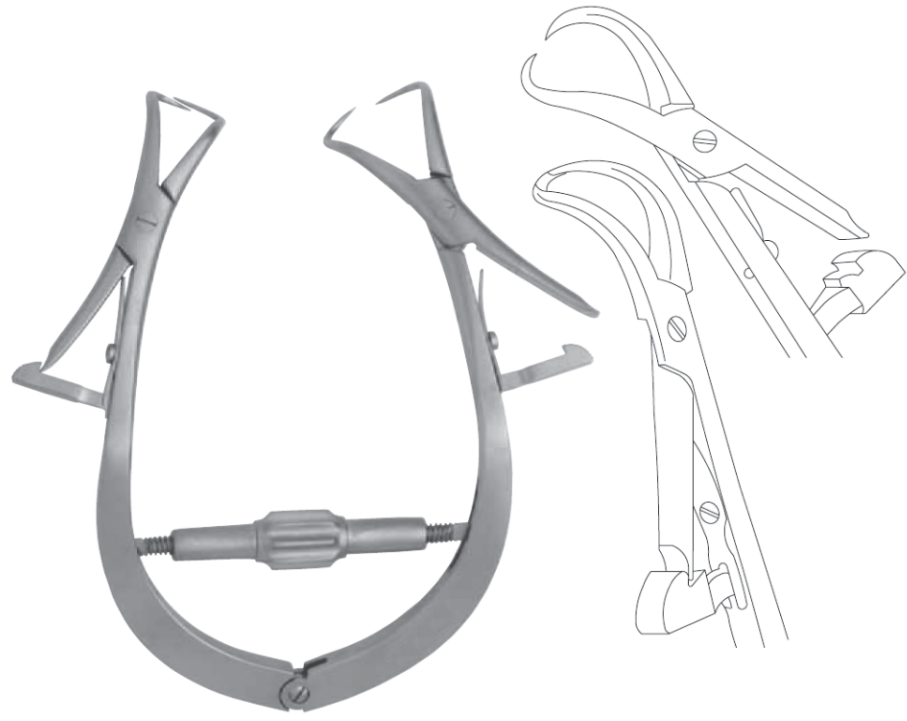

Joll
Thyroid self retaining
26-7091-15 15.5cm/6"

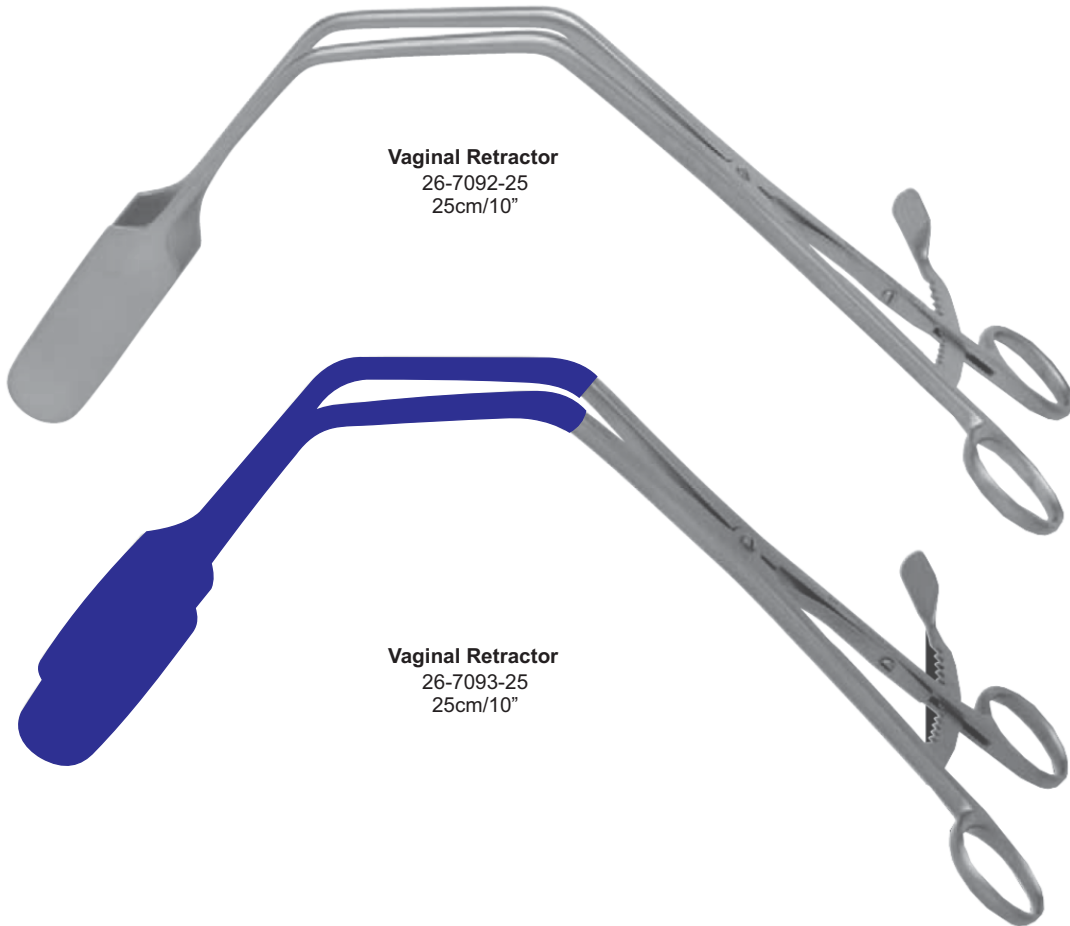
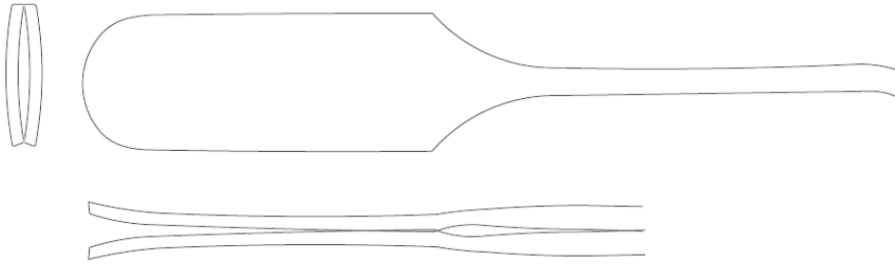

Vaginal Retractor
26-7092-25
25cm/10"

Vaginal Retractor
26-7093-25
25cm/10"



Scherbak
26-7094-00

Complete



26-7094-01
80x30 mm

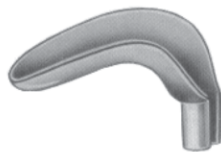

26-7094-02
85x35 mm

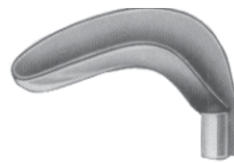

26-7094-03
90x40 mm



26-7094-04
55x40/60 mm



26-7094-05
70x45/70 mm

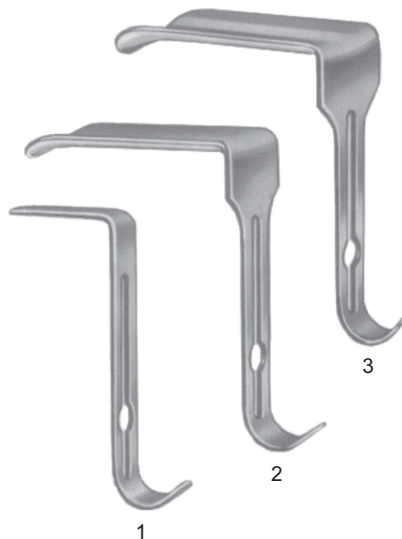

| | Fig. | a mm | b mm |
|------------|------|---------|---------|
| 26-7095-01 | 1 | 45 | 17 |
| 26-7095-02 | 2 | 90 | 37 |
| 26-7095-03 | 3 | 90 | 45 |

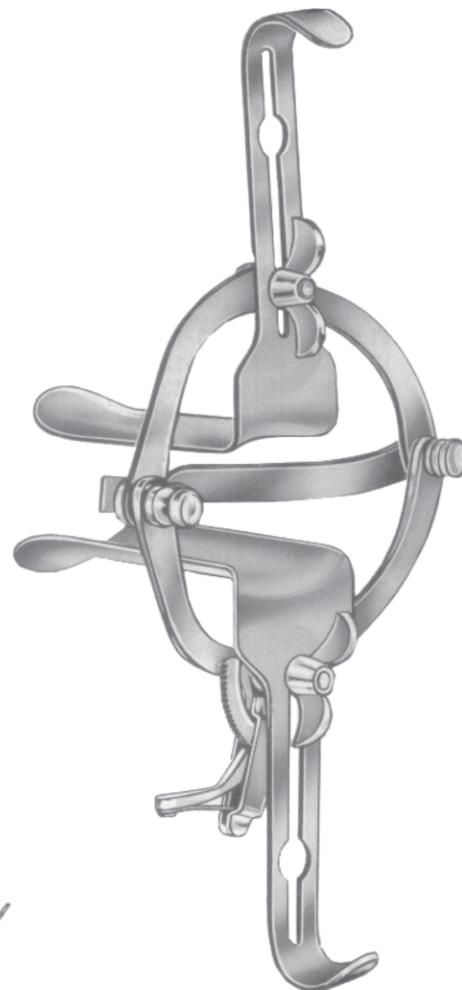

O'Sullivan-O'Connor
26-7095-00
Complete



Hegar
 single ended
 18.5 cm long

| mm Ø | |
|------|------------|
| 2.0 | 26-7096-02 |
| 3.0 | 26-7096-03 |
| 4.0 | 26-7096-04 |
| 5.0 | 26-7096-05 |
| 6.0 | 26-7096-06 |
| 7.0 | 26-7096-07 |
| 8.0 | 26-7096-08 |
| 9.0 | 26-7096-09 |
| 10.0 | 26-7096-10 |
| 11.0 | 26-7096-11 |
| 12.0 | 26-7096-12 |
| 13.0 | 26-7096-13 |
| 14.0 | 26-7096-14 |
| 15.0 | 26-7096-15 |
| 16.0 | 26-7096-16 |
| 17.0 | 26-7096-17 |
| 18.0 | 26-7096-18 |
| 19.0 | 26-7096-19 |
| 20.0 | 26-7096-20 |
| 21.0 | 26-7096-21 |
| 22.0 | 26-7096-22 |
| 23.0 | 26-7096-23 |
| 24.0 | 26-7096-24 |
| 25.0 | 26-7096-25 |
| 26.0 | 26-7096-26 |

Pieces per set

| | | |
|------------|----|-----------|
| 26-7097-50 | 12 | 3 - 14 mm |
| 26-7098-60 | 25 | 2 - 26 mm |



Hegar
 double ended
 20 cm long

| Ø mm | |
|-------|------------|
| 1/2 | 26-7099-02 |
| 3/4 | 26-7099-04 |
| 5/6 | 26-7099-06 |
| 7/8 | 26-7099-08 |
| 9/10 | 26-7099-10 |
| 11/12 | 26-7099-12 |
| 13/14 | 26-7099-14 |
| 15/16 | 26-7099-16 |
| 17/18 | 26-7099-18 |
| 19/20 | 26-7099-20 |
| 21/22 | 26-7099-22 |
| 23/24 | 26-7099-24 |
| 25/26 | 26-7099-26 |

Pieces per set

| set | |
|------------|-------------------|
| 26-7100-00 | 08 3/4 - 17/18 mm |
| 26-7100-00 | 12 1/2 - 23/24 mm |



GYNECOLOGY

Uterine Dilators
 Uterus-Dilatatoren
 Dilatadores uterinos



| mm | |
|-------|------------|
| 3/6 | 26-7102-03 |
| 4/7 | 26-7102-04 |
| 5/8 | 26-7102-05 |
| 6/9 | 26-7102-06 |
| 7/10 | 26-7102-07 |
| 8/11 | 26-7102-08 |
| 9/12 | 26-7102-09 |
| 10/13 | 26-7102-10 |
| 11/14 | 26-7102-11 |
| 12/15 | 26-7102-12 |
| 13/16 | 26-7102-13 |
| 14/17 | 26-7102-14 |
| 15/18 | 26-7102-15 |
| 16/19 | 26-7102-16 |
| 17/20 | 26-7102-17 |
| 18/21 | 26-7102-18 |

Hawkin Ambler
 26-7101-16
 17 cm long
 set of 16 3/6 - 18/21



Hank
 26-7103-30

| mm | |
|-------|------------|
| 9/10 | 26-7104-10 |
| 11/12 | 26-7104-12 |
| 13/14 | 26-7104-14 |
| 15/16 | 26-7104-16 |
| 17/18 | 26-7104-18 |
| 19/20 | 26-7104-20 |

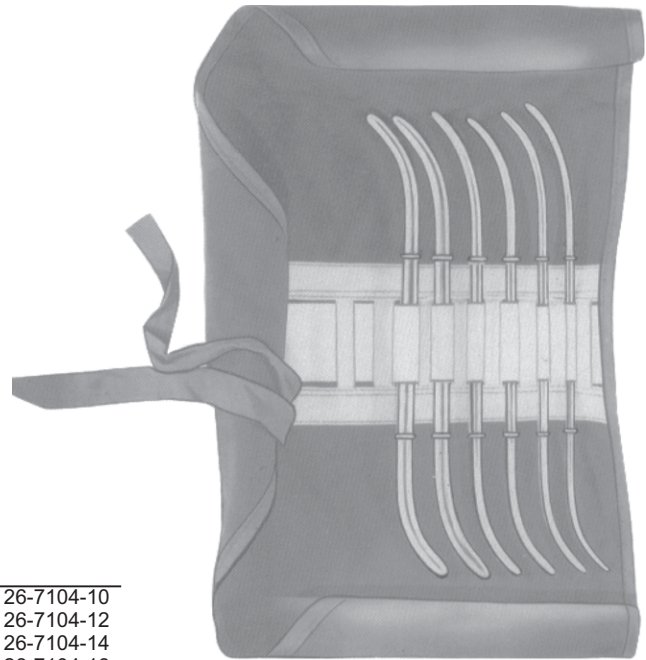

Set
 26-7105-00
 double ended
 27 cm



Pratt

| mm | |
|-------|------------|
| 13/15 | 26-7106-15 |
| 17/19 | 26-7106-19 |
| 21/23 | 26-7106-23 |
| 25/27 | 26-7106-27 |
| 29/31 | 26-7106-31 |
| 33/35 | 26-7106-35 |
| 37/39 | 26-7106-39 |
| 41/43 | 26-7106-43 |

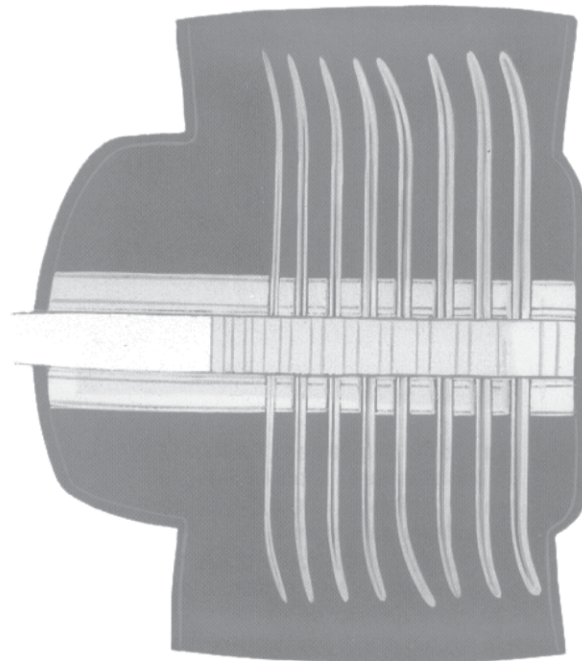

Set
 26-7107-00
 double ended
 29 cm



Tip 4 mm

Uterine Depressor



Sims
32 cm/12½"



Martin (Simpson)
32 cm/12½"



Valleix
26-7114-25
25 cm/10"



Collin
26-7115-28
28 cm/11"



Braun
26-7116-28
28 cm/11"

| | | |
|-------|------------|------------|
| Rigid | cm | cm |
| | 26-7108-32 | 26-7111-32 |

| | | |
|-----------|------------|------------|
| Malleable | cm / in | cm / in |
| | 26-7109-32 | 26-7112-32 |
| | 26-7110-32 | 26-7113-32 |



Laser Probes



26-7117-01



90°

26-7117-02



45°

26-7117-03



20°

Measuring Probe



26-7118-01

Laser Probe



26-7119-01



90°

26-7119-02



45°

26-7119-03



20°

Depth Ruler



26-7120-01



Measuring Instruments

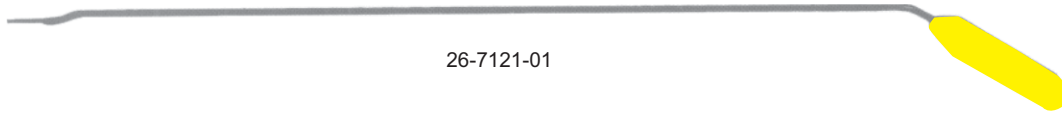

26-7121-01

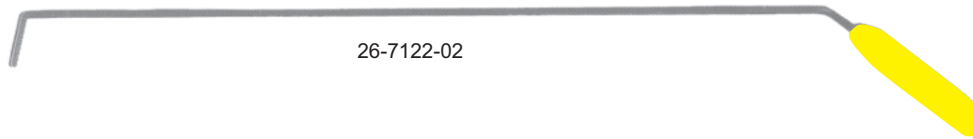

26-7122-02

Hooks



26-7123-01



26-7124-02 **Emmet**



26-7125-03



26-7126-01



26-7127-02



GYNECOLOGY

Corn Knives, Fistula Hooks, Myoma Instruments
 Konusmesser, Fistelhaken, Myom-instrumente
 Bisturi p. conos de atraccion, Ganchos p. fistulas, instrumentos para fibroma



Ayre
 26-7128-23
 23 cm/9"



Simon
 26-7129-22
 22 cm/8¾"



Simon
 26-7130-22
 22 cm/8¾"



Emmet
 22 cm/8¾"



26-7131-01



26-7131-02



26-7131-03



26-7131-04



26-7131-05



Doyen
 26-7132-17
 17 cm/6¾"



Doyen
 26-7133-17
 17 cm/6¾"



Segond
 26-7134-27
 27 cm/10½"



Secretion Spoon



26-7135-27
27 cm/10½"



Muenchen
27 cm/10½"



26-7136-04
4 mm



26-7136-05
5 mm



4 mmØ

Randall
26-7137-24
24 cm/9½"



Novak
23 cm/9"

- 26-7138-01
1 mm
- 26-7138-02
2 mm
- 26-7138-03
3 mm
- 26-7138-04
4 mm



Novak-Schoeckaert
26-7139-24
24 cm/9"



GYNECOLOGY
Suction Biopsy Curettes
Saug- und Biopsiekürettes
Curetas aspiradoras para biopsia



Kevorkian
26-7140-30
30 cm/12"

malleable
26-7141-30
30 cm/12"



Kevorkian
26-7142-30
30 cm/12"

malleable
26-7143-30
30 cm/12"



Townsend
26-7144-30
31 cm/12¼"

malleable
26-7145-30
31 cm/12¼"



Duncan
26-7146-31
31 cm/12¼"



Duncan
26-7147-31
31 cm/12¼"



Goodell
 26-7148-34
 34 cm/13½"

Black Insulated



Kogan-Laser
 28 cm/11"



26-7149-28



26-7150-28



26-7151-28
 28 cm/11"



Kogan
 26-7152-24
 24 cm/9½"



Kogan
 26-7153-24
 24 cm/9½"



Kogan
 28 cm/11"



26-7154-28



26-7155-28



GYNECOLOGY

Tenaculum Forceps
Hakenzangen
Pinzas para coger el cuello del útero



Martin
26-7156-27
27 cm/10½"

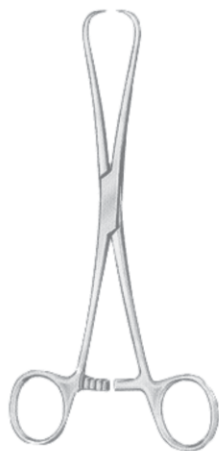

Staude-Moore
26-7157-17
17 cm/6¾"



Barrett
26-7158-18
18 cm/7"



Schroeder
26-7159-25
25 cm/10"



Braun
26-7160-25
25 cm/10"



Collin-Pozzi
26-7161-25
25 cm/10"



Pozzi
26-7162-25
25.5 cm/10¼"

Strong Pattern



Duplay
26-7163-28
28 cm/11"



Amniotome for the
 amnion Bladder



Skene
 26-7164-24
 24 cm/9½"



Beacham
 26-7165-26
 26 cm/10¼"



Czerny
 26-7166-20
 20.5 cm/8¼"



26-7167-26
 26 cm/10¼"



Schroeder
 26-7168-20 20 cm/8"
 26-7168-24 24 cm/9½"

Straight



Schroeder
 26-7169-20
 26-7169-24

Curved on Flat



Schroeder
 26-7170-20
 26-7170-24

Curved Sideway

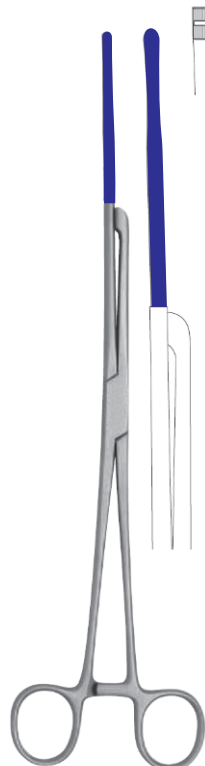

Atrauma
 26-7171-29
 Vulsellum Forcep
 29cm/11 ½"

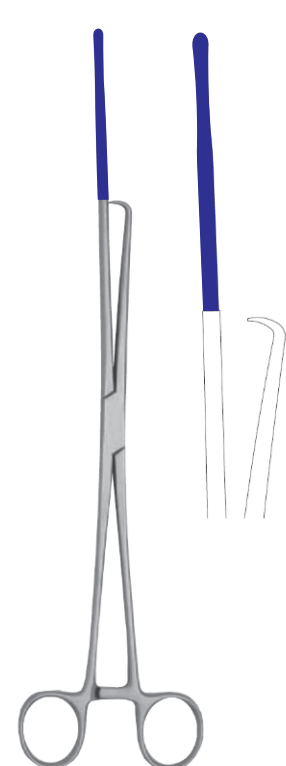

Luer
 26-7172-30
 Vulsellum Forcep
 30.5cm/12"



GYNECOLOGY

Tenaculum Forceps
Hakenzangen
Pinzas para coger el cuello del útero



Atrauma
26-7173-29
29cm/11 1/2"



Bozeman
26-7174-27
27cm/10 1/2"

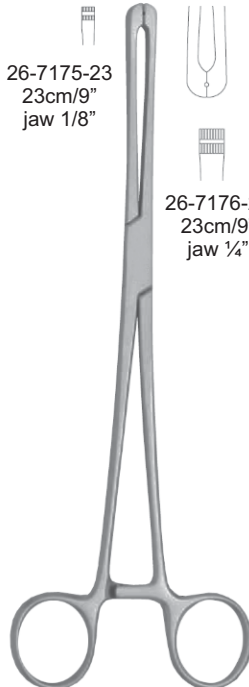

26-7175-23
23cm/9"
jaw 1/8"

26-7176-23
23cm/9"
jaw 1/4"



Rotunda
26-7177-27
27cm/10 1/2"



Bierer
26-7178-24
24cm/9 1/2"



Straight
26-7179-06
26-7179-08
26-7179-10



Museux
24 cm/9 1/2"
06 mm
08 mm
10 mm



Curved Sideway
26-7180-06
26-7180-08
26-7180-10



Straight
26-7181-06
26-7181-08
26-7181-10



Museux
24 cm/9 1/2"
06 mm
08 mm
10 mm



Curved Sideway
26-7182-06
26-7182-08
26-7182-10



Braun
26-7183-16
16 cm/6 1/4"



For the amnion Bladder



Pratt
26-7184-28
28 cm/11"



Teale
26-7185-24
24 cm/9½"



Iowa
26-7186-26
26 cm/10¼"



Jacobs
Straight Curved Sideway
26-7187-21 26-7188-21
21 cm/8¼"



Bonney Polypus
26-7189-26
24 cm/9 ½"



Kelly
26-7190-32
32 cm/12½"



Heywood-Smith
26-7191-20
20 cm/8"

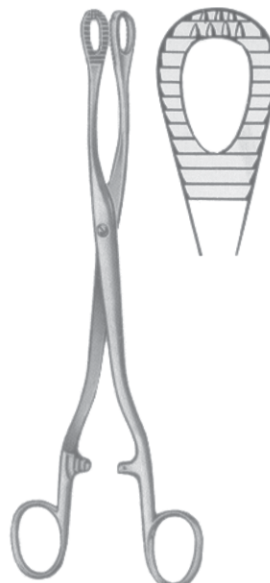

Heywood-Smith
26-7192-25
25 cm/10"



Noto
26-7193-27
27 cm/10½"



GYNECOLOGY

Uterine Elevating, Ovarian Forceps, Vaginal Clamps
Uterus-Faßzangen
Pinzas para el útero



Dartigues
26-7194-27
27 cm/10 1/2"



Somer
26-7195-23
23 cm/9"



Collin
26-7196-25
25 cm/10"

Ovarian Forceps



Doyen
26-7197-18 18 cm/7"
26-7197-20 20 cm/8"



Bonney
26-7198-34
34.5 cm/13 1/2"



Bonney
26-7199-27
27 cm/10 1/2"



Bonney
26-7200-20
20 cm/8"
curved



Bonney Berkley
26-7201-20
20 cm/8"
angled



Gellhorn
 26-7202-23
 23 cm/9"



Thoms-Gaylor
 26-7203-24
 24 cm/9½"



Schubert
 26-7204-21 21 cm/8¼"
 26-7204-29 29 cm/11¼"

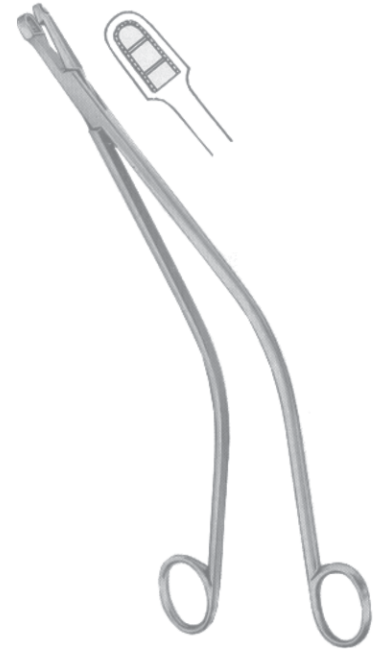

Schubert
 26-7205-26
 26 cm/10¼"



Tischler
 26-7206-27
 27 cm/10½"



Van Doren
 26-7207-25
 25 cm/10"

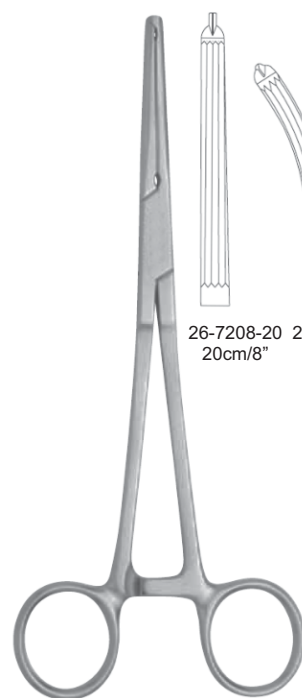

Gwilliam

26-7208-20 20cm/8"
 26-7209-20 20cm/8"



Hunter
 26-7210-23
 23 cm/9"



GYNECOLOGY

Cervical Biopsy and Specimen Forceps
Probeexzisionszangen
Pinzas saca-bocados para biopsia

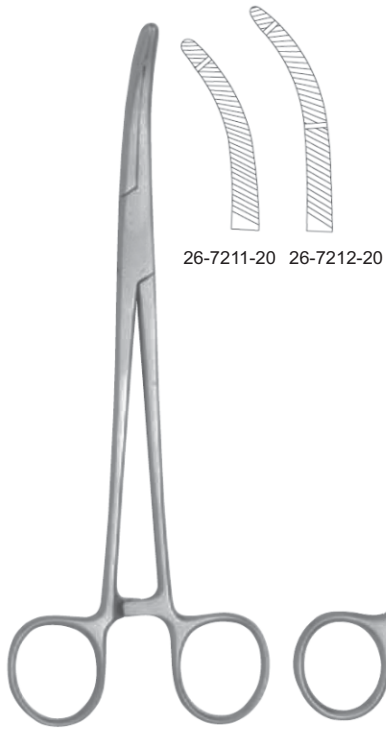

Heaney
20cm/8"

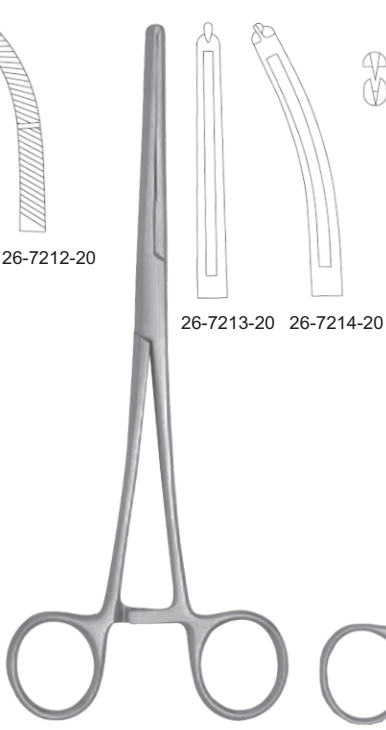

Maingot
20 cm/8"

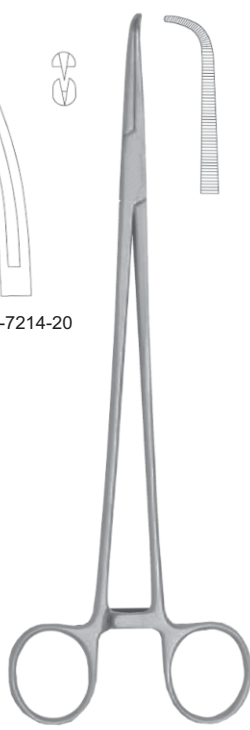

Navratill
26-7215-23
23 cm/9"



Wertheim
26-7216-25
25.5 cm/10"

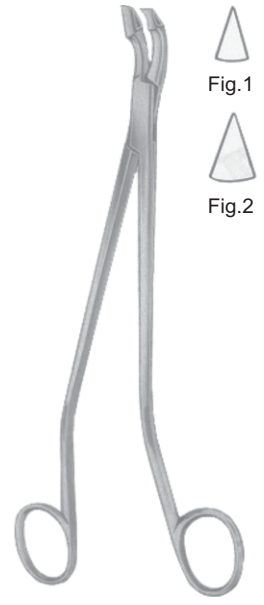

Schumacher
Fig. 1 26-7217-01 24 cm/9 1/2"
Fig. 2 26-7217-02 24 cm/9 1/2"



Faure
26-7218-21
21 cm/8 1/4"

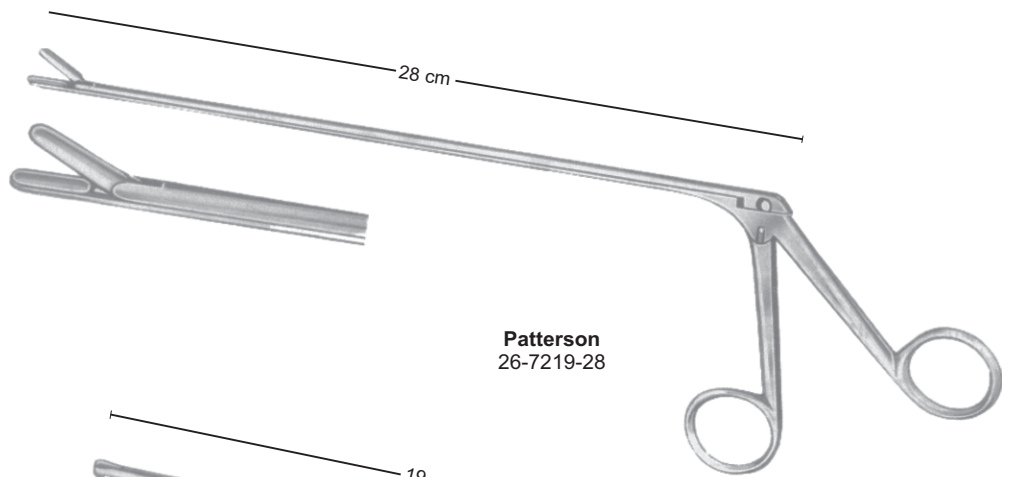

Patterson
26-7219-28

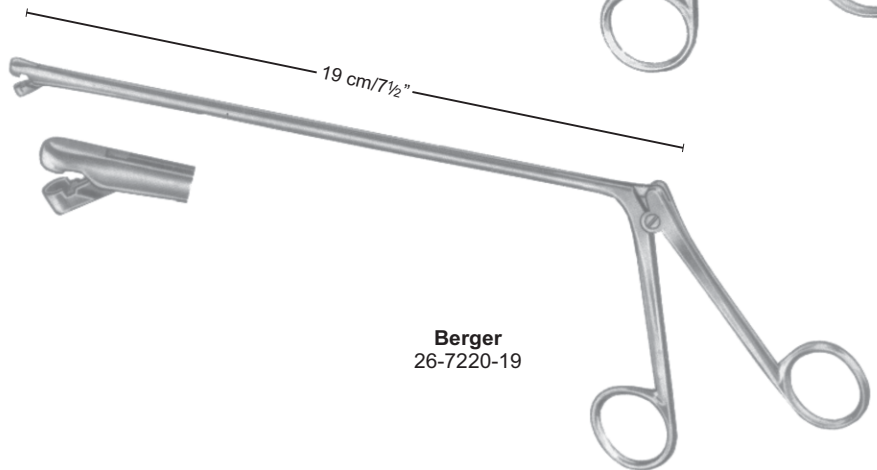

Berger
26-7220-19

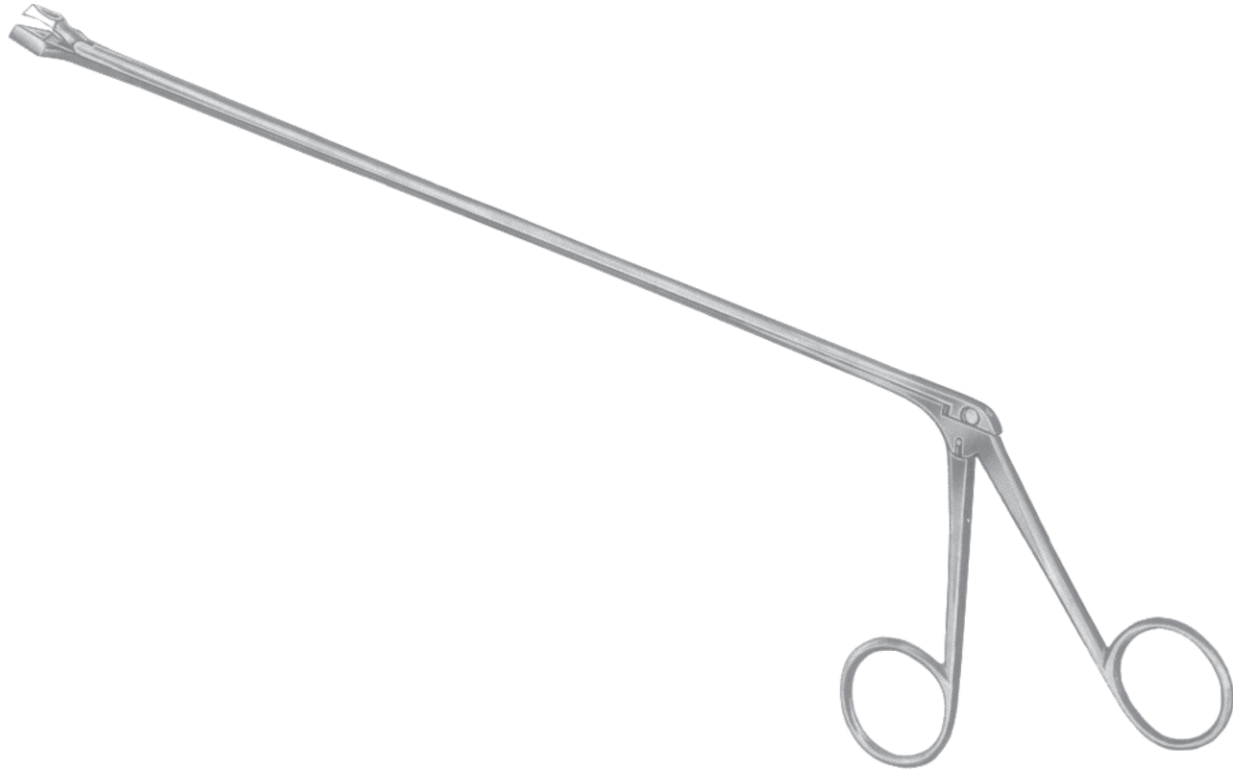

- 26-7221-20 L= 20 cm/8"
- 26-7221-25 L= 25 cm/10"
- 26-7221-30 L= 30 cm/12"
- 26-7221-35 L= 35 cm/14"
- 26-7221-40 L= 40 cm/16"



26-7223-04 26-7223-06
 4 mm 6 mm

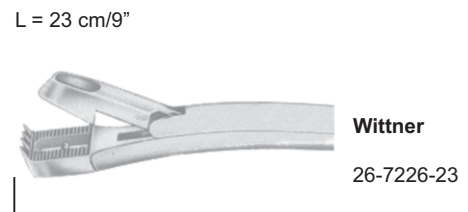
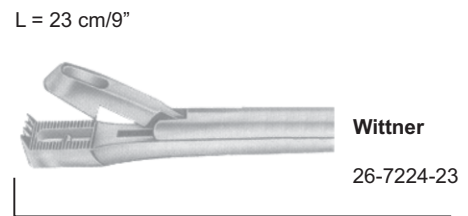
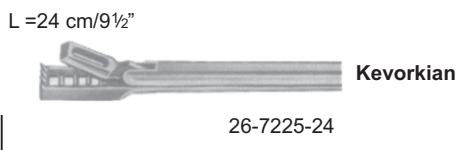



GYNECOLOGY

Cervical Biopsy and Specimen Forceps
Probeexzisionszangen
Pinzas saca-bocados para biopsia

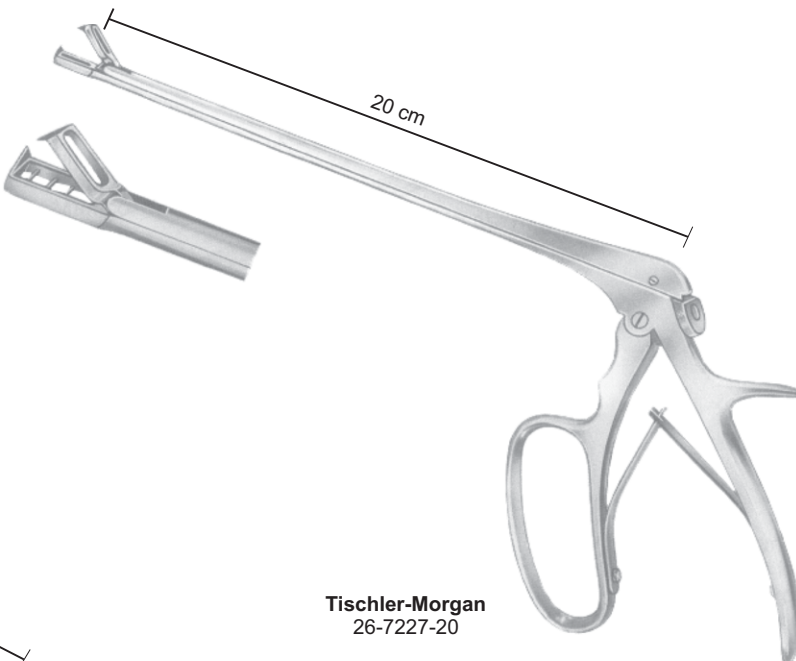

Tischler-Morgan
26-7227-20

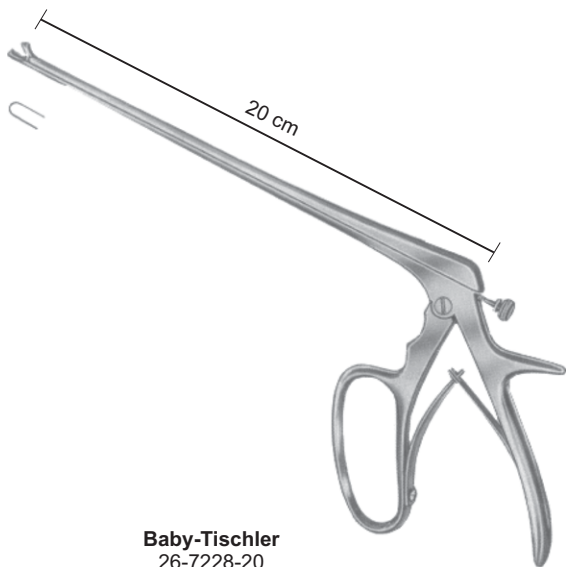

Baby-Tischler
26-7228-20

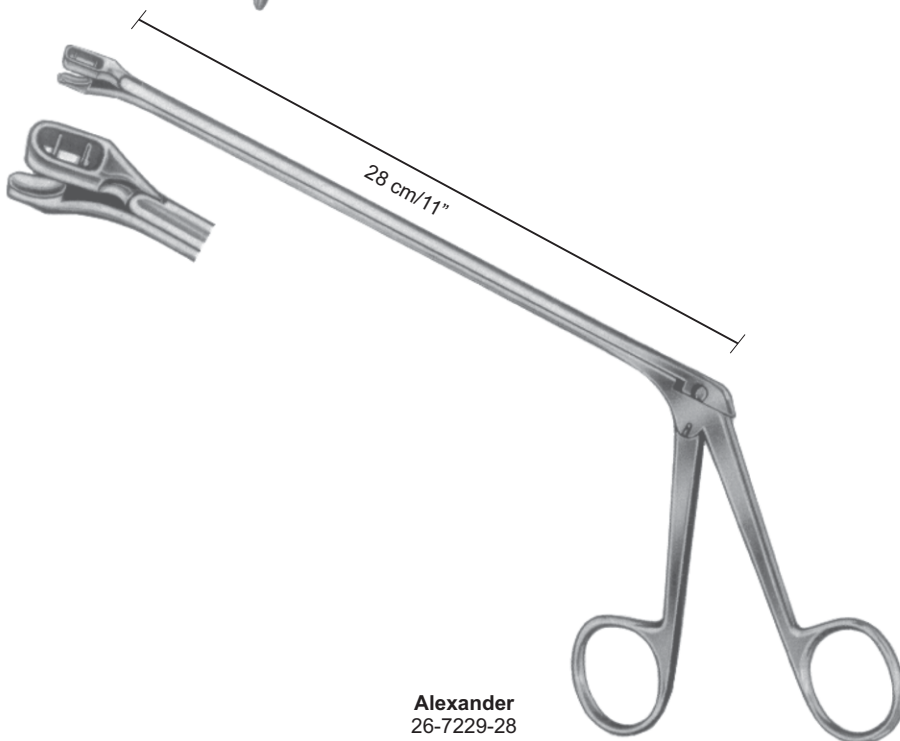

Alexander
26-7229-28

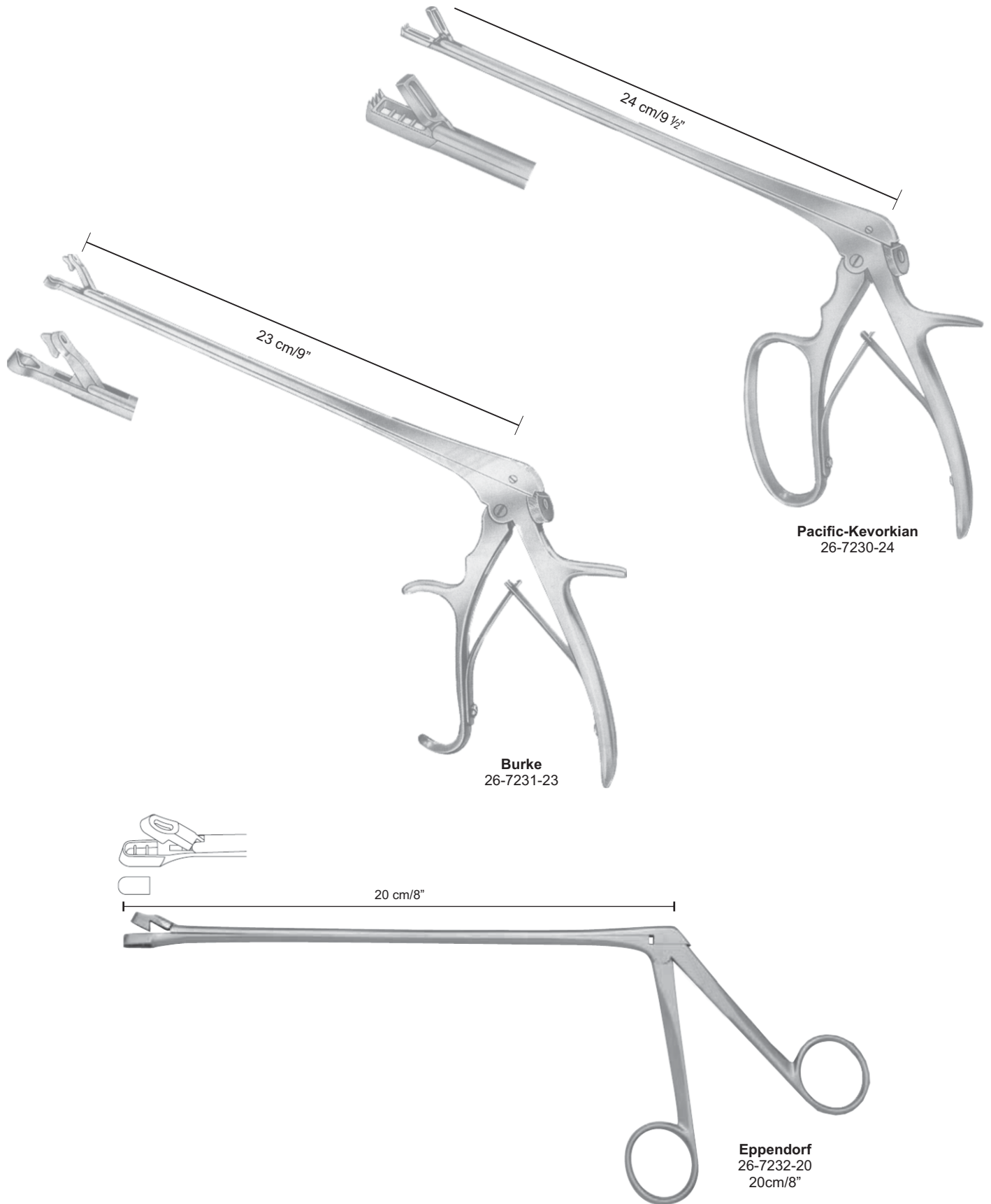



GYNECOLOGY

Cervical Biopsy and Specimen Forceps
 Probeexzisionszangen
 Pinzas saca-bocados para biopsia













Handle



Tip with tube

Townsend

| | | Complete instrument | Tip, only |
|---|--|---------------------|------------|
|  | Tischler | 26-7233-00 | 26-7234-01 |
|  | Kevorkian | 26-7235-00 | 26-7236-01 |
|  | Mini-Townsend | 26-7237-00 | 26-7238-01 |
|  |  Tischler-up | 26-7239-00 | 26-7240-01 |
|  |  Tischler-down | 26-7241-00 | 26-7242-01 |
|  |  Mini-Townsend-up | 26-7243-00 | 26-7244-01 |
|  |  Mini-Townsend-down | 26-7245-00 | 26-7246-01 |



Schroeder
 30 cm/12"

Sharp Rigid



Fig. 1
 26-7247-01
 26-7248-01



Fig. 2
 26-7249-02
 26-7250-02



Fig. 3
 26-7251-03
 26-7252-03

Schroeder
 Simon



Fig. 4
 26-7253-04
 26-7254-04



Fig. 5
 26-7255-05
 26-7256-05



Fig. 6
 26-7257-06
 26-7258-06

Schroeder
 Simon



Simon
 25 cm/10"



Gourdet
 28 cm/11"



Fig. 1
 26-7259-01
 6 mm



Fig. 2
 26-7259-02
 8 mm



Fig. 3
 26-7259-03
 10 mm



Fig. 4
 26-7259-04
 12 mm



Fig. 5
 26-7259-05
 14 mm



Thomas



Fig. 1
26-7260-01



Fig. 2
26-7260-02



Fig. 3
26-7260-03



Fig. 4
26-7260-04



Fig. 5
26-7260-05



Fig. 6
26-7260-06



Greene

26-7261-10
10 mm

26-7261-12
12 mm

26-7261-14
14 mm



Collin
26-7262-30
30 cm/12"



Heaney
26-7263-24
24 cm/9½"



Heaney
26-7264-24
24 cm/9½"



Milan
28.5 cm/11¼"

Malleable



26-7265-05
5 mm Ø

Rigid

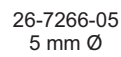

26-7266-05
5 mm Ø



26-7267-07
7 mm Ø

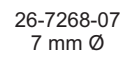

26-7268-07
7 mm Ø



26-7269-09
9 mm Ø

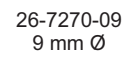

26-7270-09
9 mm Ø



28 cm/11"

Hose Connecting Piece



26-7272-00

| | Ø |
|------------|---------|
| 26-7271-04 | 4.0 mm |
| 26-7271-06 | 6.0 mm |
| 26-7271-08 | 8.0 mm |
| 26-7271-10 | 10.0 mm |
| 26-7271-12 | 12.0 mm |
| 26-7271-14 | 14.0 mm |
| 26-7271-16 | 16.0 mm |



Sims
25 cm/10"

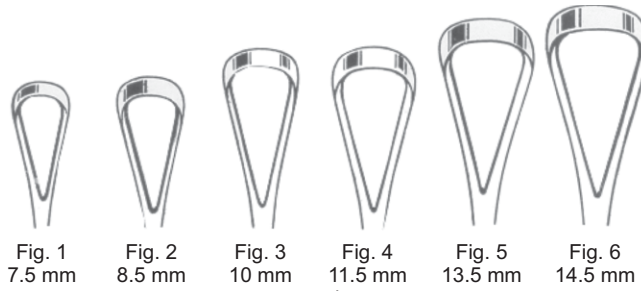

| | | Malleable | | Rigid | |
|--------|------------|-----------|------------|------------|------------|
| | | Sharp | Blunt | Sharp | Blunt |
| Fig. 1 | 26-7273-01 | | 26-7274-01 | 26-7275-01 | 26-7276-01 |
| Fig. 2 | 26-7273-02 | | 26-7274-02 | 26-7275-02 | 26-7276-02 |
| Fig. 3 | 26-7273-03 | | 26-7274-03 | 26-7275-03 | 26-7276-03 |
| Fig. 4 | 26-7273-04 | | 26-7274-04 | 26-7275-04 | 26-7276-04 |
| Fig. 5 | 26-7273-05 | | 26-7274-05 | 26-7275-05 | 26-7276-05 |
| Fig. 6 | 26-7273-06 | | 26-7274-06 | 26-7275-06 | 26-7276-06 |



Sims
25 cm/10"

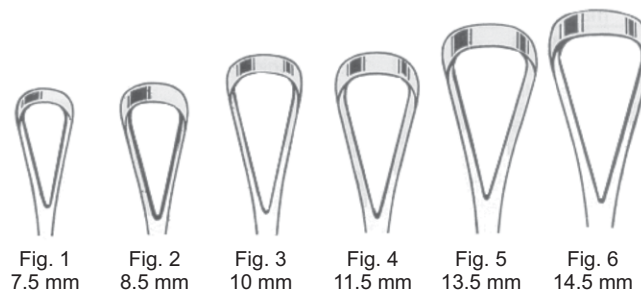

| | | Malleable | | Rigid | |
|--------|------------|-----------|------------|------------|------------|
| | | Sharp | Blunt | Sharp | Blunt |
| Fig. 1 | 26-7277-01 | | 26-7278-01 | 26-7279-01 | 26-7280-01 |
| Fig. 2 | 26-7277-02 | | 26-7278-02 | 26-7279-02 | 26-7280-02 |
| Fig. 3 | 26-7277-03 | | 26-7278-03 | 26-7279-03 | 26-7280-03 |
| Fig. 4 | 26-7277-04 | | 26-7278-04 | 26-7279-04 | 26-7280-04 |
| Fig. 5 | 26-7277-05 | | 26-7278-05 | 26-7279-05 | 26-7280-05 |
| Fig. 6 | 26-7277-06 | | 26-7278-06 | 26-7279-06 | 26-7280-06 |

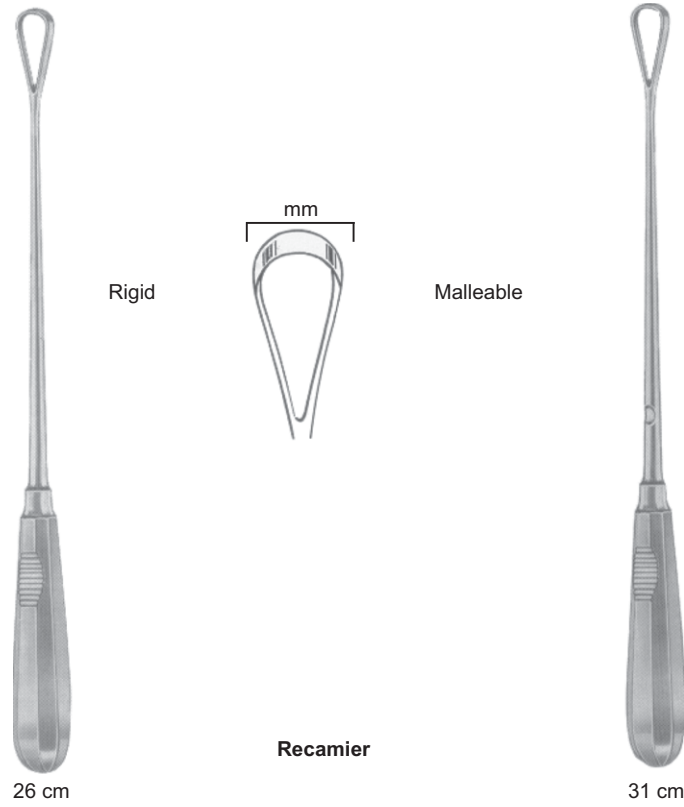

| Fig. | mm | Malleable | | Rigid | | Malleable | | Rigid | |
|------|----|------------|------------|------------|------------|------------|------------|------------|------------|
| | | Sharp | Blunt | Sharp | Blunt | Sharp | Blunt | Sharp | Blunt |
| 00 | 5 | 26-7281-05 | 26-7282-05 | 26-7283-05 | 26-7284-05 | 26-7285-05 | 26-7286-05 | 26-7287-05 | 26-7288-05 |
| 0 | 6 | 26-7281-06 | 26-7282-06 | 26-7283-06 | 26-7284-06 | 26-7285-06 | 26-7286-06 | 26-7287-06 | 26-7288-06 |
| 1 | 7 | 26-7281-07 | 26-7282-07 | 26-7283-07 | 26-7284-07 | 26-7285-07 | 26-7286-07 | 26-7287-07 | 26-7288-07 |
| 2 | 8 | 26-7281-08 | 26-7282-08 | 26-7283-08 | 26-7284-08 | 26-7285-08 | 26-7286-08 | 26-7287-08 | 26-7288-08 |
| 3 | 9 | 26-7281-09 | 26-7282-09 | 26-7283-09 | 26-7284-09 | 26-7285-09 | 26-7286-09 | 26-7287-09 | 26-7288-09 |
| 4 | 10 | 26-7281-11 | 26-7282-11 | 26-7283-11 | 26-7284-11 | 26-7285-11 | 26-7286-11 | 26-7287-11 | 26-7288-11 |
| 5 | 12 | 26-7281-12 | 26-7282-12 | 26-7283-12 | 26-7284-12 | 26-7285-12 | 26-7286-12 | 26-7287-12 | 26-7288-12 |
| 6 | 14 | 26-7281-14 | 26-7282-14 | 26-7283-14 | 26-7284-14 | 26-7285-14 | 26-7286-14 | 26-7287-14 | 26-7288-14 |
| 7 | 15 | 26-7281-15 | 26-7282-15 | 26-7283-15 | 26-7284-15 | 26-7285-15 | 26-7286-15 | 26-7287-15 | 26-7288-15 |
| 8 | 16 | 26-7281-16 | 26-7282-16 | 26-7283-16 | 26-7284-16 | 26-7285-16 | 26-7286-16 | 26-7287-16 | 26-7288-16 |
| 9 | 19 | 26-7281-19 | 26-7282-19 | 26-7283-19 | 26-7284-19 | 26-7285-19 | 26-7286-19 | 26-7287-19 | 26-7288-19 |
| 10 | 20 | 26-7281-20 | 26-7282-20 | 26-7283-20 | 26-7284-20 | 26-7285-20 | 26-7286-20 | 26-7287-20 | 26-7288-20 |
| 11 | 21 | 26-7281-21 | 26-7282-21 | 26-7283-21 | 26-7284-21 | 26-7285-21 | 26-7286-21 | 26-7287-21 | 26-7288-21 |
| 12 | 23 | 26-7281-23 | 26-7282-23 | 26-7283-23 | 26-7284-23 | 26-7285-23 | 26-7286-23 | 26-7287-23 | 26-7288-23 |
| 13 | 25 | | | | | 26-7285-25 | 26-7286-25 | 26-7287-25 | 26-7288-25 |
| 14 | 30 | | | | | 26-7285-30 | 26-7286-30 | 26-7287-30 | 26-7288-30 |
| 15 | 35 | | | | | 26-7285-35 | 26-7286-35 | 26-7287-35 | 26-7288-35 |
| 16 | 40 | | | | | 26-7285-40 | 26-7286-40 | 26-7287-40 | 26-7288-40 |



Bumm
max. 29 cm/11½"

| Fig. | mm | Mealleable | |
|------|------|------------|------------|
| | | Sharp | Blunt |
| 0 | 16.0 | 26-7289-16 | 26-7290-16 |
| 1 | 18.0 | 26-7289-18 | 26-7290-18 |
| 2 | 19.5 | 26-7289-19 | 26-7290-19 |
| 3 | 21.5 | 26-7289-21 | 26-7290-21 |
| 4 | 23.5 | 26-7289-23 | 26-7290-23 |
| 5 | 26.0 | 26-7289-26 | 26-7290-26 |
| 6 | 28.5 | 26-7289-28 | 26-7290-28 |



Blunt

Sharp

Blake (Zweifel)
26-7291-27 27 cm/10½"
26-7291-31 31 cm/12¼"

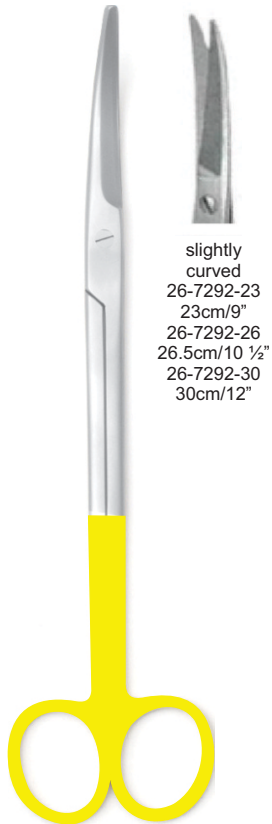

**Zeppelin Scissor
with TC**

slightly
curved
26-7292-23
23cm/9"
26-7292-26
26.5cm/10 1/2"
26-7292-30
30cm/12"

curved
26-7293-23
23cm/9"
26-7293-26
26.5cm/10 1/2"
26-7293-30
30cm/12"

Fully
curved
26-7294-23
23cm/9"
26-7294-26
26.5cm/10 1/2"
26-7294-30
30cm/12"



Straight Slightly Curved Strongly Curved Angled

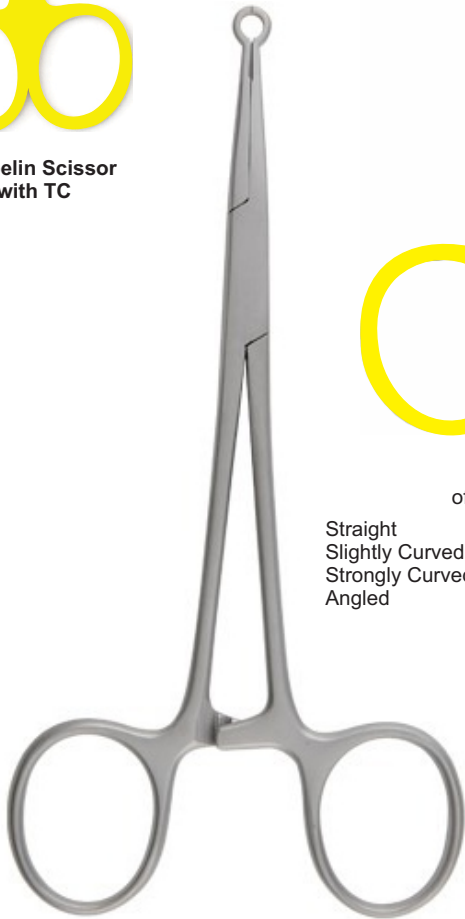

26-7327-12
Ring Forceps 5"

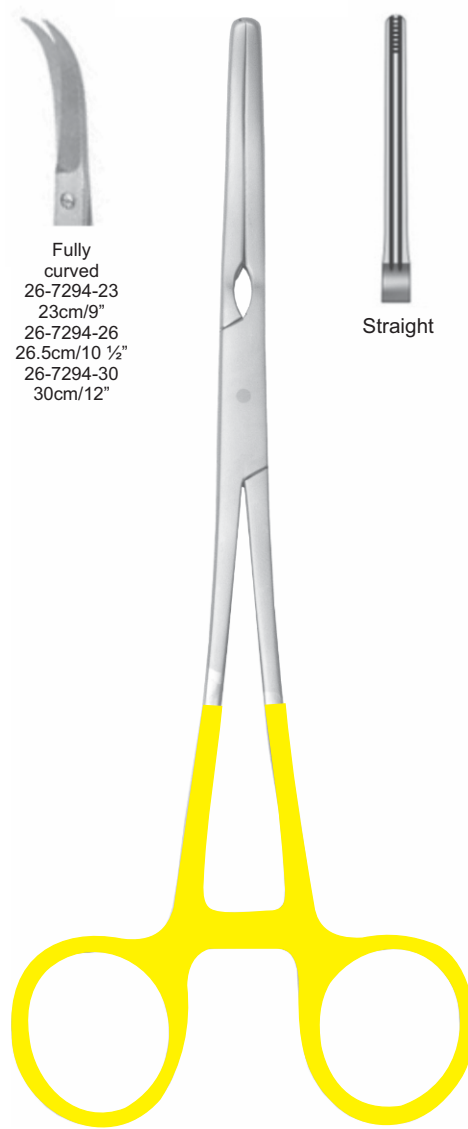

Zeppelin Clamps

offset handle with gold rings (without TC)

| | | | | |
|-----------------|---------------|-------------|------------|------------|
| Straight | 26-7295-21 | 26-7299-24 | 26-7303-30 | 26-7307-35 |
| Slightly Curved | 26-7296-21 | 26-7300-24 | 26-7304-30 | 26-7308-35 |
| Strongly Curved | 26-7297-21 | 26-7301-24 | 26-7305-30 | 26-7309-35 |
| Angled | 26-7298-21 | 26-7302-24 | 26-7306-30 | 26-7310-35 |
| | 21.5cm/8 1/2" | 24cm/9 1/2" | 30cm/12" | 35cm/14" |

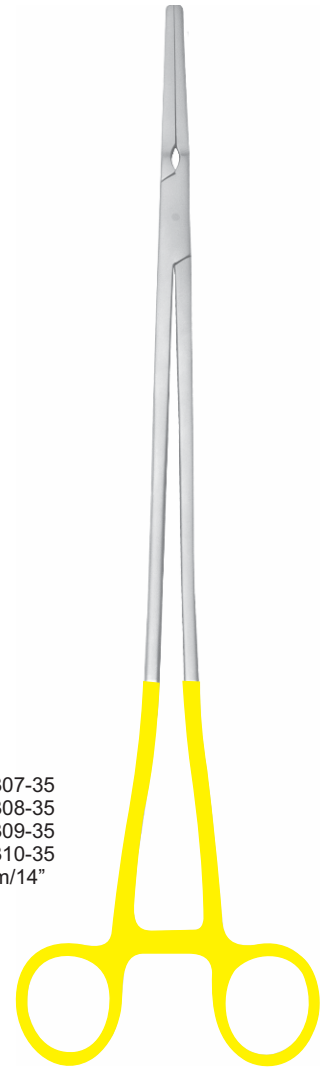

Zeppelin Clamps

Straight Handle with gold rings (without TC)

| | | | | |
|-----------------|---------------|-------------|------------|------------|
| Straight | 26-7311-21 | 26-7315-24 | 26-7319-30 | 26-7323-35 |
| Slightly Curved | 26-7312-21 | 26-7316-24 | 26-7320-30 | 26-7324-35 |
| Strongly Curved | 26-7313-21 | 26-7317-24 | 26-7321-30 | 26-7325-35 |
| Angled | 26-7314-21 | 26-7318-24 | 26-7322-30 | 26-7326-35 |
| | 21.5cm/8 1/2" | 24cm/9 1/2" | 30cm/12" | 35cm/14" |